

Ceramic Filter, Duplexer and Multiplexer (Mono-Block & Discrete Type)

Ceramic Filter

Part Number	Freq. Range (MHz)	I.L (dB) max	R.L (dB) min	Imped. (ohms)	Attenuation (dB) / min	Dimension W x L x H (mm)
MCF300B30L1.7A40 (Ceramic Encased BPF)	285 ~ 315	1.7	20.	50	40 at 240 MHz 40 at 360 MHz	70x60x32 SMA Female
DR8E382.5B5L3.0A75	380~385	3.0	15	50	75 at Fo-65MHz, 75 at Fo+65MHz	44.0x23.0x9.50
DR6D407B5L3.5A20	405~410	3.5	13	50	20 at 415~420MHz	27.0x24.0x7.00
DR6D417.5B5L3.5A20	415~420	3.5	13	50	20 at 425~430MHz	27.0x24.0x7.00
DR8E422.5B5L3.0A75	420~425	3.0	15	50	75 at Fo-65MHz, 75 at Fo+65MHz	44.0x23.0x9.50
MCF490B20L2.7A70 (Ceramic Encased BPF)	480 ~ 500	2.7	15	50	70 at 530~750 MHz 50 at 750~900 MHz	95x50x32 SMA Female
DR6E555B90L1.5A50	510~600	1.5	15	50	50 at 755MHz	32.0x25.0x8.00
DR4D668.8B17.5L2.5A50	660 ~ 677.5	2.5	15	50	50 at Fc-70MHz, 50 at Fc+70MHz	13.6x13.0x4.50
DR4D701.3B17.5L2.5A50	692.5~710	2.5	15	50	50 at Fc-70 MHz ,50 at Fc+70MHz	13.6x13.0x4.50
MCF720B15L1.7A40 (Ceramic Encased BPF)	712.5 ~ 727.5	1.7	20	50	40 at 690 MHz 40 at 750 MHz	70x60x32 SMA Female
M8J721B60L2.5A30	691~751	2.5	15	50	30at 671 MHz, 30 at 771~1000MHz	40.5x10.0x8.00
MR8H742.5B29L3.0 A28	728-757	3.0	15	50	28 at 698~716 MHz, 776~787 MHz	37.0x12.0x9.20
DCF3350B500L1.5A300 (Ceramic Encased BPF)	3100~3600	1.5	14	50	30 at 2750 MHz 60 at 2400 MHz	50x35x18 SMA Female
DR6E780B180L1.5A10	690~870	1.5	12	50	10 at 630,930 MHz	32.0x25.0x8.00
MR4H806B30L4.5A40	791~821	4.5	15	50	40 at DC~771, 832~862 MHz	22.0x13.0x5.50
DR8F815B18L2.5A60	806 ~ 824	2.5	15	50	60 at 851~869 MHz	50.8x17.0x9.50
MR4D829.5B13L2.5A25A	823~836	2.5	15	50	25 at 784.5 MHz, 25 at 874.5 MHz	13.6x13.0x4.70
DC6G830B72L3.0A70 (Ceramic Encased BPF)	794 ~ 866	3.0	15	50	70 at 690 MHz 70 at 970 MHz	60x34x15 SMA Female
M4C836.5B25L3.0A7	824~849	3.0	12	50	35 at 911~1016 / 35 at 1158~1183	8.69x9.78x4.00
MR4D840B12L2.5A20A	834~846	2.5	15	50	25 at Fo+/-45 MHz	13.6x13.0x5.00
M6F860B18L3.5A55	851~869	3.5	15	50	50 at 806~824, 50 at 896~915 MHz	23.0x9.70x7.90
MR4D874.5B13L2.5A25A	868~881	2.5	15	50	25 at Fo +/-45 MHz	13.6x13.0x4.70
DR8F897.5B35L2.5A60	880~915	2.5	15	50	60 at 647~797.5, 10 at 797.5~870	50.8x15.5x9.50
M6E902.5B25L2.0A30	890~915	2.0	18	50	30 at 935 MHz	13.5x12.5x6.25
MR4D909B14L3.0A25A	902~916	3.0	14	50	25dBc at 864 , 954 MHz	13.6x13.0x4.70
M4B914B2L2.5A17S	913~915	2.5	10	50	17 at 889 MHz, 17 at 939 MHz	7.60x8.85x3.80
M6E921B6L2.0A35S	918~924	2.0	10	50	40 at 831 MHz , 35 at 1011 MHz	13.5x8.30x6.10
MR4D939B18.5L3.0A30A	930~948.5	3.0	14	50	30 at Fo+/-45 MHz	13.6x13.0x4.70
DR7G942.5B15L3.5A77	935~950	3.5	15	50	77at DC~905,68 at 1100~1800	46.0x18.0x10.0
M6E947.5B25L2.0A30	935~960	2.0	18	50	30 at 915 MHz	13.5x11.8x6.25
MR4D954B14L3.0A25A	947~961	3.0	14	50	25dBc at 909, 999 MHz	13.6x13.0x5.00
DR6E954B13L3.0A50	947~960	3.0	14	50	20 at 930, 975, 60 at DC~888 MHz	31.14x16.99x7.5
M4B959B2L2.5A15S	958~960	2.5	10	50	15 at 984 MHz , 17 at 934 MHz	7.60x8.40x3.80

Ceramic Filter, Duplexer and Multiplexer (Mono-Block & Discrete Type)

Ceramic Filter

Part Number	Freq. Range (MHz)	I.L (dB) max	R.L (dB) min	Imped. (ohms)	Attenuation (dB) / min	Dimension W x L x H (mm)
M4C1050B20L3.0A40	1040~1060	3.0	15	50	40 at 825~960,40 at 1140~1410MHz	8.69x7.54x3.87
DR4H1116B62L3.0A45W	1085~1147.5	3.0	14	50	45 at Fo+62.5, 50 at Fo-62.5 MHz	32.0x13.0x5.00
DR3E1250B100L3.6A50	1200 ~ 1300	3.6	15	50	45 at 1500 MHz, 50 at 2500 MHz	19.0x12.7x7.00
MR10J1400B100L2.0A60	1350~1450	2.0	15	50	60 at 1250 ~ 1300, 1500 MHz	55.0x14.0x11.5
MR3B1485B10L2.0A20	1480~1490	2.0	14	50	20 at 1405, 1570 MHz	7.50x7.50x4.40
M6E1505B40L2.5A20	1485~1525	2.5	14	50	20 at 1420~1460 , 1555~1595 MHz	13.5x7.80x6.20
M8J1555B20L2.5A40	1545~1565	2.5	15	50	40 at 1510 MHz, 40 at 1610 MHz	40.5x7.50x8.00
MR10J1600B100L2.0 A60	1550 ~ 1650	2.0	15	50	60 at 1500, 1700 MHz	55.0x14.0x11.5
DR3D1650B50L2.0A60	1625~1675	2.0	14	50	60 at 1324~1325 MHz	13.0x12.0x4.50
DR3D1732.5B45L2.5A55	1710~1755	2.5	15	50	55 at DC~1580, 45 at 1885 MHz	13.0x12.0x4.50
MF1737B55L2.0A22	1710~1765	2.0	14	50	22 at <1665, 22 at >1810 MHz	13.50x7.40x6.20
MR4C1772.5B30L1.5A20A	1757.5~1787.5	1.5	14	50	20 at 1867.5 MHz	13.6x13.0x5.0
MR4C1842.5B27L1.5A20A	1829~1856	1.5	14	50	20 at 1747.5 MHz	13.6x13.0x4.7
DRF1880B60L3.0A20	1850~1910	3.0	15	50	20 at 1930 ~ 1990 MHz	26.0x16.0x6.50
WR22F1932.5B15L2.5A20M	1925-1940	2.5	15.0	50	20 at DC-1919.6MHz	104.8x33.0x12.8 (Connector type)
DR6E1937.5B15L5.0A60	1930~1935	5.0	14	50	50 at 500~1850 MHz, 60 at 1850~1865MHz	31.14x16.99x7.50
DR4C1942.5 B19 L2.0 A20	1933~1952	2.0	14	50	20 at 2132.5 MHz	13.6x13.0x 5.50
MF1950B60L2.0A30	1920~1980	2.0	12	50	30 at 1750~1815, 4 at 1900, 2000	8.69x5.50x3.87
DR6G1960B60L6.0A40	1930~1990	6.0	10	50	40 at 1850~1910, 2060~2600 MHz	44.0x13.0x8.0
MR4C2067.5B95L2.0A30	2020~2115	2.0	15	50	30 at 1900 MHz, 30 at 2280 MHz	13.0x12.0x5.0
DR5E2132.5B15L2.8A50	2125~2140	2.8	14	50	50 at 1942.5 MHz	26.0x15.0x6.50
MR4C2162B19L1.8A20A	2153~2172	1.8	14	50	20 at 1972.5 MHz	13.6x13.0x4.70
MC6E2250B100L1.0A30S (Ceramic Encased BPF)	2200~2300	1.0	15	50	30 at 2090,2390 MHz 5 at 6000 MHz	26.0x20.0x15.0 SMA Female
MR3B2300B10L2.0A18	2295~2305	2.0	14	50	18 at 2215 MHz ,20 at 2380 MHz	7.50x7.50x4.40
WR18D2312.5B27L1.0A35	2300-2327	1.0	15.0	50	35 at 2213.5, 2413.5 MHz	62.44x27.6x10.8
DR3D2317.5B105L2.0A45	2265~2370	2.0	16	50	45 at 2590~5000 MHz	13.0x12.0x4.50
WR18D2345B27L1.0A35	2331.5-2358.5	1.0	15.0	50	10 at 2295,2395MHz 35 at 2245, 2445MHz	62.44x27.6x10.8
DRF2350B100L1.0A50	2300~2400	1.0	14	50	50 at 1900 MHz	13.0x12.0x4.50
WR18E2350B100L1.0A70S	2300-2400	1.0	15.0	50	70 at 2100MHz 50 at 2550MHz	66.5x22.3x11.8 (Connector type)
DR5E 2437 B50 L3.3 A28	2412 ~ 2462	3.3	13	50	28 at 2300~2390, 2486~2570 MHz	26x14x6.5
DR5E 2442 B68 L2.0A18	2408 ~ 2476	2.0	13	50	18 at 2375~2385, 2500~2510 MHz	26x14x6.5
WR18F2550B100L0.8A80S	2500-2600	0.8	15.0	50	80 at 2300MHz 50 at 2750MHz	75.7x19.6x10.0 (Connector type)

Ceramic Filter, Duplexer and Multiplexer (Mono-Block & Discrete Type)

Ceramic Filter

Part Number	Freq. Range (MHz)	I.L (dB) max	R.L (dB) min	Imped. (ohms)	Attenuation (dB) / min	Dimension W x L x H (mm)
WR18F2550B100L0.8A80S	2500-2600	0.8	15.0	50	80 at 2300MHz, 50 at 2750MHz	75.7x19.6x10.0 (Connector type)
WR17F2550B100L0.6A60P	2500-2600	0.6	15.0	50	60 at 2300MHz, 50 at 2750MHz	75.2x19.8x20.0 (Pin type)
WR18E2590B24L2.2A35	2578-2602	2.2	15	50	35 at 2560MHz, 35 at 2620MHz	76.6x21.2x10.7
DR4C2650B60L3.0A60	2620~2680	3.0	14	50	45 at Fo+300 MHz, 60 at Fo-300 MHz	14.0x12.0x4.50
MR8J2700B400L2.0A50	2500~2900	2.0	15	50	50 at DC~2300, 3100~3500 MHz	45.0 x13.0x9.20
MR8J2900B400L2.0A60	2700~3100	2.0	15	50	60 at 2500, 60 at 3300 MHz	43.0x12.0x9.00
DR4H3000B500L1.0A50	2750~3250	1.0	14	50	50 at 2000~2400, 3600~4000 MHz	34.5x16.5x5.50
MR6J3300B400L2.0A30	3100~3500	2.0	14	50	30 at 2900, 3700 MHz	30.0x9.60x7.00
DCF3350B500L1.5A300 (Ceramic Encased BPF)	3100~3600	1.5	14	50	30 at 2750 MHz, 60 at 2400 MHz	50x35x18 SMA Female
MR6F3375B100L2.0A50	3325 ~ 3425	2.0	15	50	50 at 3100, 3650 MHz	26.5x10.5x7.50
M6F3450B20L2.0A25	3440~3460	2.0	14	50	25 at 3540~3560 MHz	25.0x6.50x6.20
M6F3526.5B54L2.0A25	3499.5~3553.5	2.0	14	50	25 at 3399.5~3453.5 MHz	25.0x6.50x6.20
WR18E3500B200L1.0A55S	3400-3600	1.0	15	50	20 at 3300, 3700MHz 55 at 2900, 4000MHz	68.8x21.1x19.8 (Connector type)
WR8F3500B150L2.0A45	3425-3575	2.0	12	50	45 at 3300MHz, 35 at 3700MHz	36.0x11.0x6.0
MR4H3600B440L0.8A45	3578~3622	8.0	14	50	45 at 3530 , 3670 MHz	2.64x1.12x0.58
WR17D3615B50L2.0A60	3590-3640	2.0	12	50	60 at 3415MHz, 60 at 3815MHz	44.346x20.0x10.0
MF4C3750B100L1.5A30	3700~3800	1.5	12	50	30 at 3220~3320 MHz	6.90x 4.50x 4.80
WR6E4502B20L2.5A80	4492-4512	2.5	12.0	50	80 at 4288-4300MHz	54.0x23.0x8.0
M4D4750B500L2.0A35	4500~5000	2.0	14	50	50 at 1500~2500, 35 at 6750 MHz	10.3 x 4.30 x 4.0
WR6E5002B20L2.5A80	4992-5012	2.5	12.0	50	80 at 4788-4808MHz	54.0x23.0x8.0
WR8F5095L3.0A60	4990-5200	3.0	12	50	60 at 4510-4720MHz 50 at 5320-5700MHz	43.5x11.0x6.0
M2C5300B100L3.0A30	5250~5350	3.0	10	50	20 at 4950 MHz, 30 at 5619 MHz	7.10x5.0x3.10
WR8G5400B300L1.5A30	5250-5550	1.5	12	50	30 at 5090MHz, 30 at 5680MHz	43.5x11.0x6.0
WR18D5585B80L1.0A40S	5545-5625	1.0	12	50	40 at 5385MHz, 40 at 5785MHz	56.14x21.3x10.6 (Connector type)
M2C5650B150L3.0A30	5575~5725	3.0	10	50	20 at 5275 MHz, 30 at 5944 MHz	7.10x5.0x3.10
WR8F5770B240L2.0A25	5650-5890	2.0	12.0	50	25 at 5550MHz	36.0x11.0x6.0
M2C5787.5B125L3.0A30	5725~5850	3.0	10	50	20 at 5424 MHz, 30 at 6094 MHz	7.10x5.0x3.10
WR8E5800B150L2.5A40	5725-5875	2.5	12	50	40 at 5600MHz, 30 at 5800MHz	37.35x13.8x6.7
WR12E5850B50L2.5A30	5825-5875	2.5	12.0	50	30 at 5725-5775MHz	55.84x21.0x10.8
M4C6050B250L3.0A20	5925~6175	3.0	14	50	20 at Fc±500 MHz	7.20x3.85x3.40
M4C6300B250L3.0A20	6175~6425	3.0	14	50	20 at Fc±500 MHz	7.20x3.85x3.40
WR14E6675B100L4.0A35	6625-6725	4.0	12.0	50	30 at 6580 MHz, 30 at 6790 MHz	46.0x20.0x8.5
WR12D7550B200L2.5A40	7450-7650	2.5	12.0	50	40 at 7340 MHz, 40 at 7770 MHz	34.0x18.0x7.5

Ceramic Filter, Duplexer and Multiplexer (Mono-Block & Discrete Type)

Ceramic Filter

Part Number	Freq. Range (MHz)	I.L (dB) max	R.L (dB) min	Imped. (ohms)	Attenuation (dB) / min	Dimension W x L x H (mm)
WR10D8150B100L3.0A50	8100-8200	3.0	12.0	50	50 at 8000 MHz, 50 at 8540 MHz	34.0x16.0x6.5
W8C10200 B30 L3.0 A30	10185 ~10215	3.0	12	50	30 at 10350 MHz, 30 at 10050 MHz	18.80x8.80x4.40
W8C10550 B30 L3.0 A30	10535 ~10565	3.0	12	50	30 at 10400 MHz, 30 at 10700 MHz	17.80x8.80x4.40
WR10C12800B200L3.0A30	12700-12900	3.5	12.0	50	30 at 12320 MHz, 30 at 13420 MHz	22.0x14.0x6.5
WR10D13700B200L3.0A40	12700-12900	3.5	12.0	50	40 at 12940 MHz, 40 at 14690 MHz	26.0x14.0x6.5
WR8C15650B300L3.0A30	15500-15800	3.5	12.0	50	30 at 14860 MHz, 30 at 16770 MHz	18.0x12.0x5.5

► Performance

◆ DR5E 2442 B68 L2.0A18

◆ DR5E 2437 B50 L3.3 A28

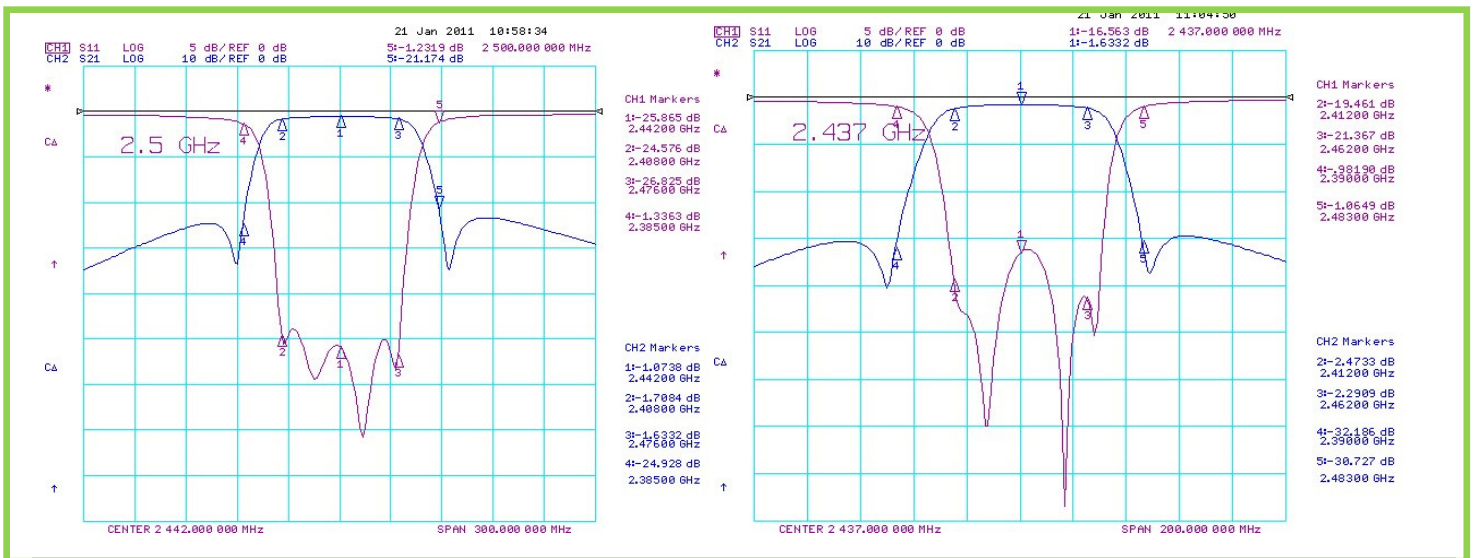

► Dimension(mm) (DR5E 2442 B68 L2.0A18 / DR5E 2437 B50 L3.3 A28)

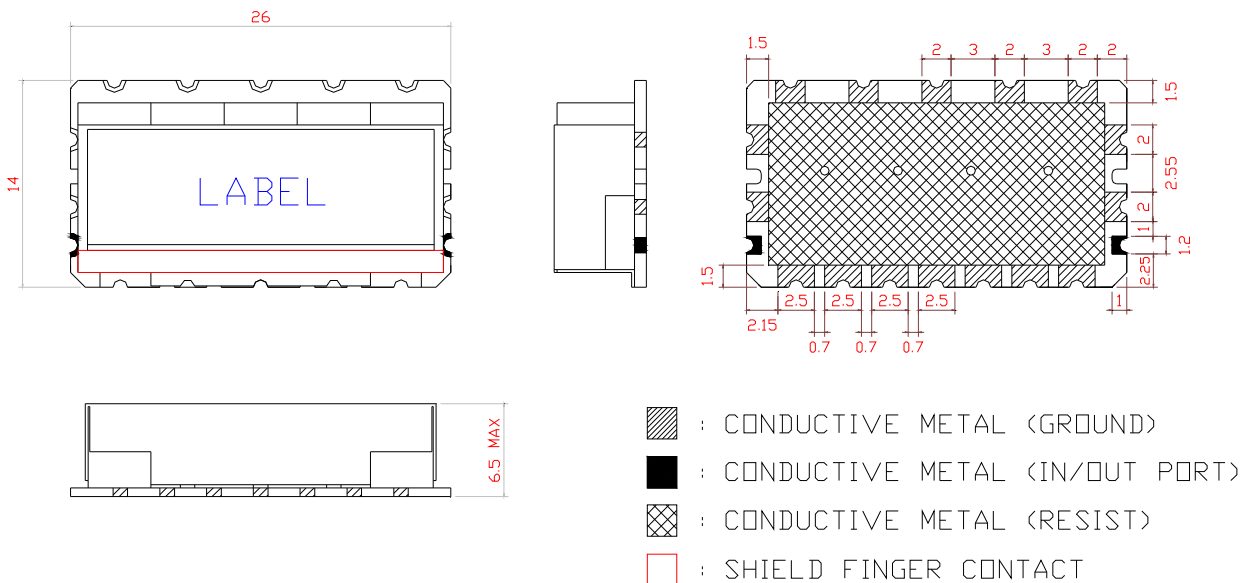

■ Ceramic Filter, Duplexer and Multiplexer(Mono-Block & Discrete Type)

Ceramic Filter

◆ DC6H771.5-898.5-2200B147-5-1000L3.0A15N(Ceramic Encased BPF)

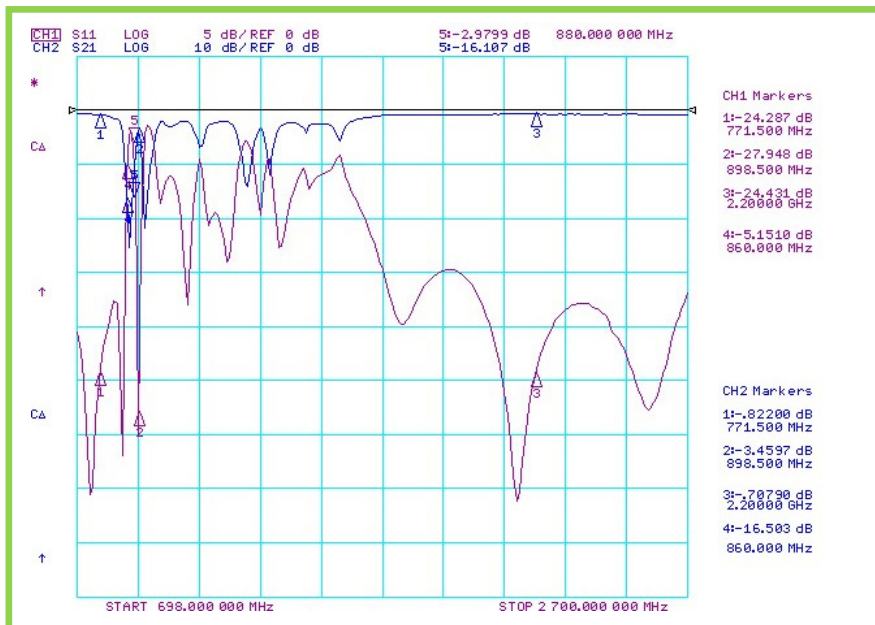
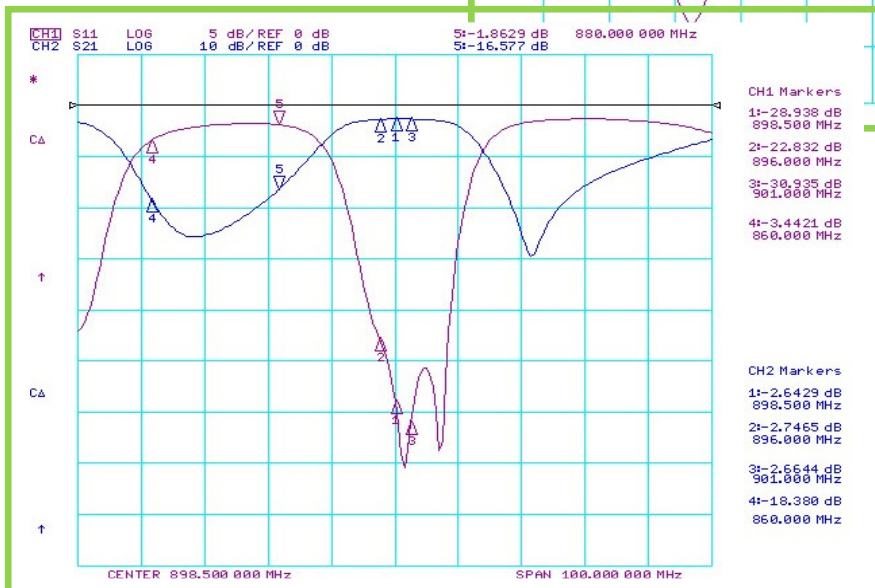
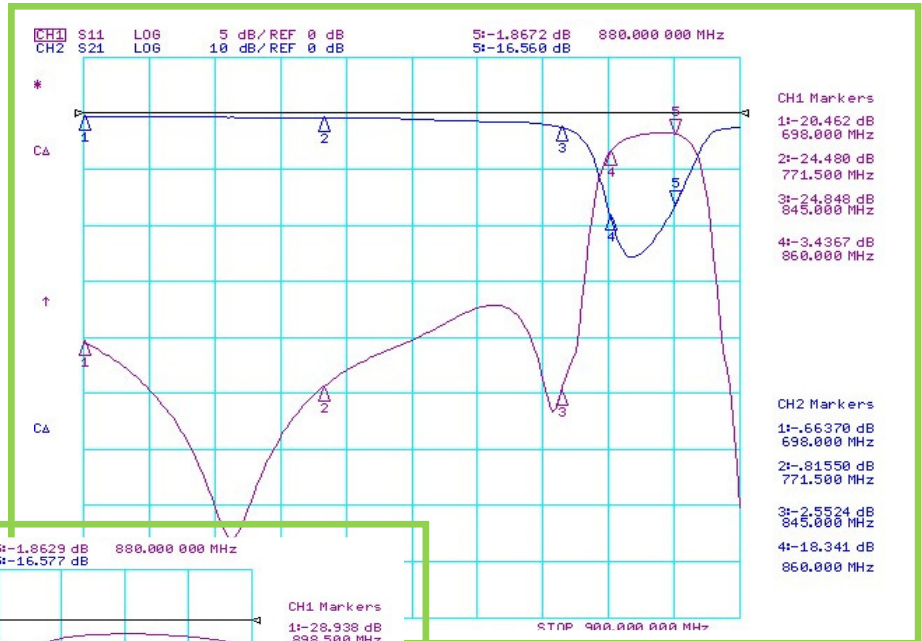

■ Ceramic Filter, Duplexer and Multiplexer(Mono-Block & Discrete Type)

Ceramic Filter

► Dimension(mm)(DC6H771.5-898.5-2200B147-5-1000L3.0A15N(Ceramic Encased BPF))

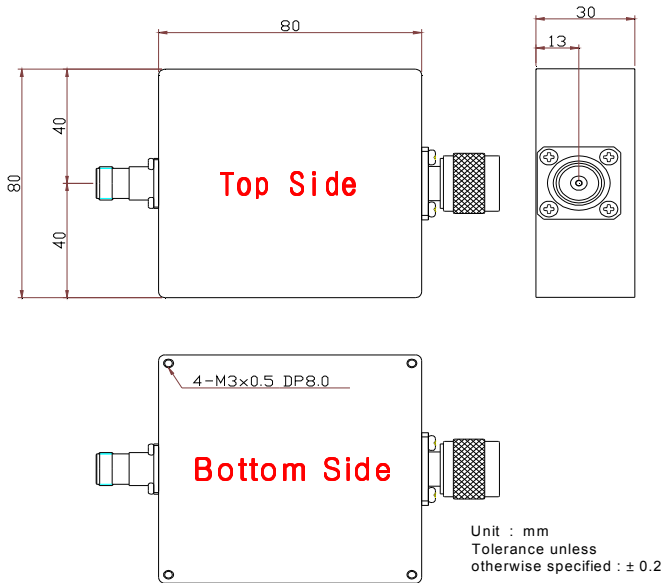

◆ DC6G830B72L3.0A70 (Ceramic Encased BPF)

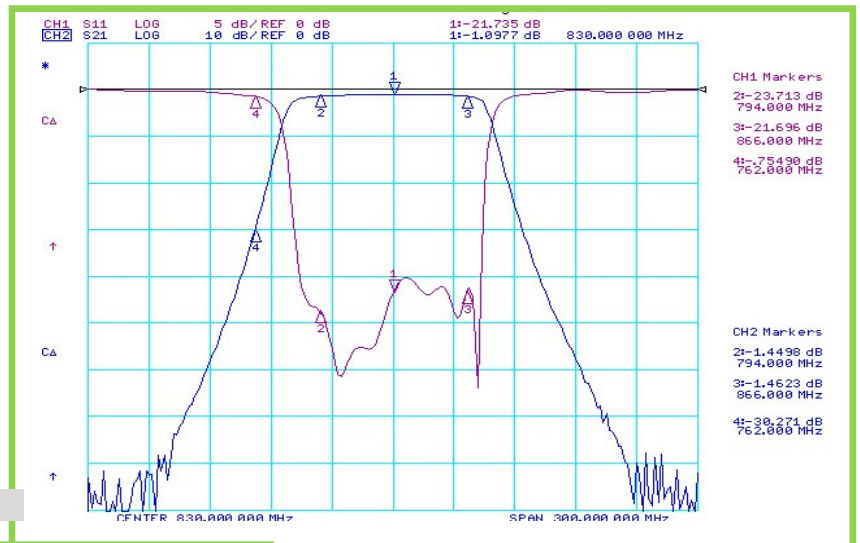

► Dimension(mm)
(DC6G830B72L3.0A70 (Ceramic Encased BPF))

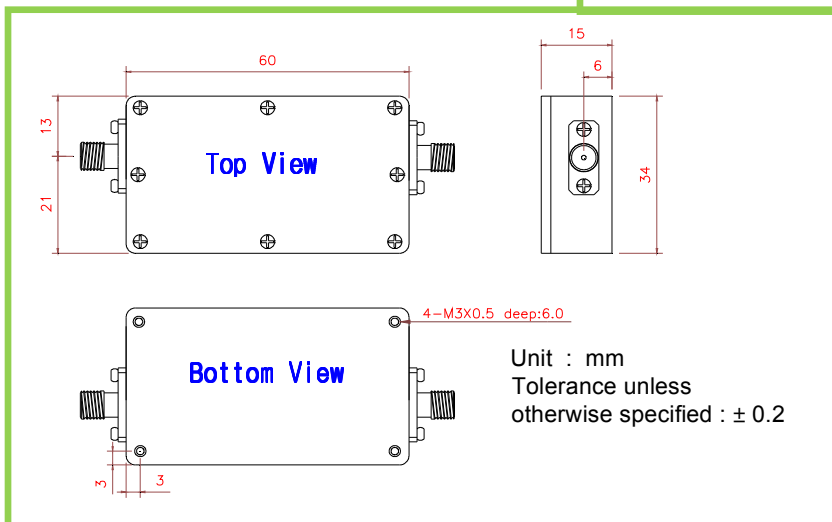

■ Ceramic Filter, Duplexer and Multiplexer(Mono-Block & Discrete Type)

Ceramic Filter

◆W8C10200 B30 L3.0 A30(TE MODE)

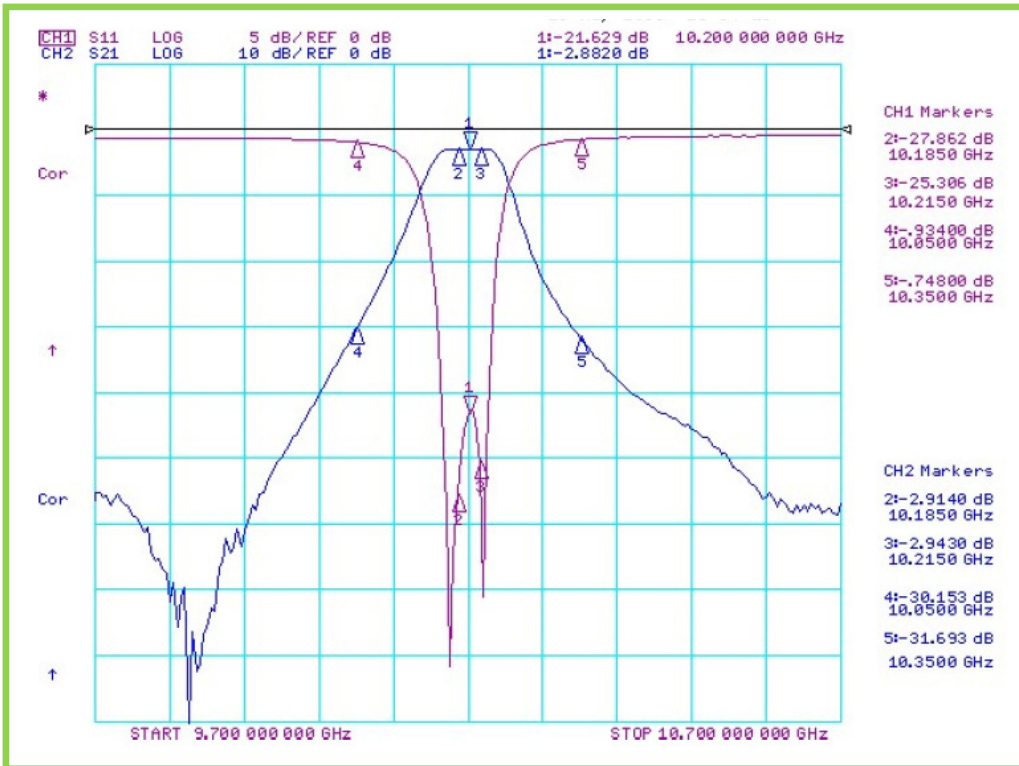

► Dimension(mm)(W8C10200 B30 L3.0 A30(TE MODE)

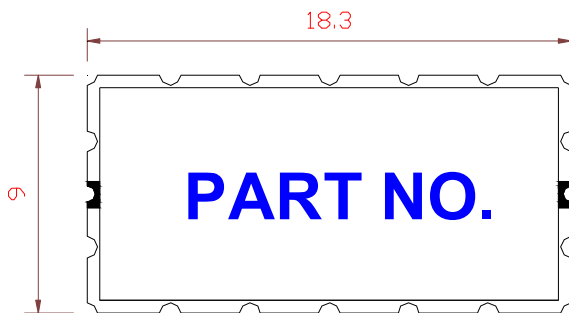

Top Side

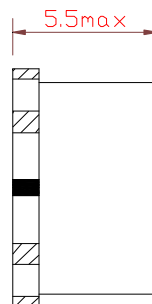
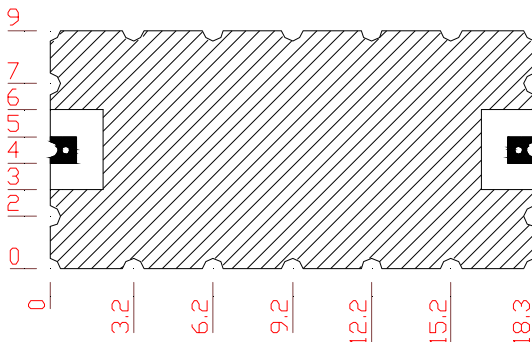

Ceramic Filter, Duplexer and Multiplexer (Mono-Block & Discrete Type)

Ceramic Duplexer

Part Number	Freq. Range (MHz)	I.L (dB) max	R.L (dB) min	Imped. (ohms)	Attenuation (dB) / min	Dimension W x L x H (mm)
DRD381/391B3L3.5A50S	L: 380~383 H: 390~393	3.5 3.5	17	50	50 at 390~393MHz 50 at 380~383 MHz	140x55x27
MR15L382.5F392.5B5L2.5R1.0A42	L: 380~385 H: 390~395	2.5	15	50	42 at 390~395 MHz 42 at 380~385 MHz	79.5x22.0x16.0
MR15DJ382.5F392.5B5L4.0A70	L: 380~385 H: 390~395	4.0	15	50	70 at 390~395 MHz 70 at 380~385 MHz	79x54x17
DR4F497F938 B794-6 L1.0-2.5 A40	L: 100-894 H: 935~941	1.0 2.5	14 16	50	42 at 390~395 MHz 42 at 380~385 MHz	32.0x13.7x5.50
MR15L412.5F422.5B5L2.5R1.0A42	L: 410~415 H: 420~425	2.5	15	50	42 at 420~425 MHz 42 at 410~415 MHz	79.5x22.0x16.0
MR15L455F465B5L3.0A48	L: 452.5~457.5 H: 462.5~467.5	3.0	15	50	48 at 462.5~467.5 48 at 452.5~457.5	79.5x22.0x16.0
MR12J567.5F652.5B51L2.5A40	L: 542~593 H: 627~678	2.5	14	50	40 at 627~678 MHz 40 at 542~593 MHz	54.0x23.0x13.3
MR10J647.5F732.5B51L2.5A40-43	L: 623~672 H: 708~757	2.5	14	50	40 at 708~757 MHz 43 at 623~672 MHz	54.0x23.0x13.3
MR8J707F781.5 B18-11 L3.0 A23	L: 698~716 H: 776~787	3.0	15	50	23 at 776~787 MHz 30 at 698~716 MHz	42.0x13.2x9.0
MC15L392.5F427 B5-2 L2.0 A60S (Ceramic Encased Duplexer)	L: 390~395 H: 426~428	2.0	15	50	60 at 426~428 MHz 60 at 390~395 MHz	85x45x32 SMA Female
MR8H767F860B18L1.5A25	L: 758~776 H: 851~869	1.5	15	50	25 at 851~1000 MHz 25 at 758~776 MHz	36.0x18.0x9.20
DR6J742.5F881.5B29-25L2.5A50	L: 623~672 H: 708~757	2.5	15	50	50 at DC-650 MHz 50 at 1050~1300 MHz	65.0x15.0x8.00
M8H769/860B14/18L1.2A16	L:762~776 H:851~869	1.2	15	50	16 at 851~869 MHz 16 at 762~776 MHz	32.4x13.7x8.20
MR8J806F847 B30 L3.0 A45	L: 791~821 H: 832~962	3.0	14	50	45 at 832~962 MHz 45 at 791~821 MHz	45.0x18.0x9.20
DR8H815F860B18L2.0A60	L: 806~824 H: 851~869	2.0	16	50	60 at 851~869 MHz 60 at 806~824 MHz	65.0x25.0x9.50
MCD815F860B18L3.0A25 (Ceramic Encased Duplexer)	L: 806~824 H: 851~869	3.0	15	50	25 at 851~869 MHz 25 at 806~824 MHz	123x71x30 SMA Female
M8J827F902.5B44-25L2.0 A25	L: 805 ~ 849 H: 890 ~ 915	2.0	14	50	25 at 896~902 MHz 25 at 806~849 MHz	40.5x13.4x8.20
MR15DJ836.5R881.5B25L3.0A70	L: 824~849 H: 869~894	3.0	15	50	70 at 869~894 MHz 70 at 824~849 MHz	79x54x17
M8H871.5F938B43-6L1.4A40	L: 851~894 H: 935~941	1.4	16	50	40 at 935~941 MHz 40 at 851~896 MHz	32.0x12.5x8.20
MR15DJ897.5F942.5B35L3.5 A70	L: 880~915 H: 925~960	3.5	16	50	70 at 925~960 MHz 70 at 880~915 MHz	74.0x48.0x17.0
MR10L836F881B25L2.0A60	L: 824~849 H: 869~894	2.0	15	50	60 at 869~894 MHz 60 at 824~849 MHz	65.0x21.0x11.5
MR15DJ836.5F881.5 B25 L3.0 A70	L: 824~849 H: 869~894	3.0	16	50	70 at 869~894 MHz 70 at 824~849 MHz	74.0x48.0x17.0
M8J840/923B60-73L4.5A45	L:810~870 H:887~960	4.5 4.5	13	50	45 at 887~960 MHz 45 at 810~870 MHz	40.5x13.2x8.20
M8H847/860B20L1.5A50	L: 850~870 H: 935~960	1.5	16	50	50 at 935~960 MHz 50 at 850~870 MHz	40.5x12.9x8.0
M8H860/938B18-6L1.2A40	L:851~869 H:935~941	1.2	16	50	40 at 935~941 MHz 40 at 851~869 MHz	32.0x12.5x8.20
MD871.5F938B43-6L1.4A40	L: 850~893 H: 935~941	1.4	16	50	40 at 935~941 MHz 40 at 850~893 MHz	32.0x12.5x8.20
M8J872.5F942.5 B43-35 L2.0 A25	L: 851~894 H: 925~960	2.0	0.5	50	25 at 925~960 MHz 25 at 851~894 MHz	40.50x12.90x8.0

Ceramic Filter, Duplexer and Multiplexer (Mono-Block & Discrete Type)

Ceramic Duplexer

Part Number	Freq. Range (MHz)	I.L (dB) max	R.L (dB) min	Imped. (ohms)	Attenuation (dB) / min	Dimension W x L x H (mm)
M4J885F941B10-6L1.2A40	L: 880~890 H: 938~944	1.2	16	50	40 at 938~944 MHz 40 at 880~891 MHz	32.0x12.5x8.20
MD890/937B25L3.0A50W	L: 880~905 H: 925~950	3.0 3.5	12	50	50 at 925~950 MHz 50 at 880~905 MHz	26.5x9.17x4.10
M8J897.5F942.5B35L3.5A45	L: 880~915 H: 925~960	3.5	15	50	40 at 925~960 MHz 40 at 880~915 MHz	40.5x14.0x8.0
MCD897.5F942.5B35L3.0A25 (Ceramic Encased Duplexer)	L: 880~915 H: 925~960	3.0	15	50	25 at 925~960 MHz 25 at 880~915 MHz	123x71x30 SMA Female
MR15DJ897.5R942.5B35 L3.5 A70	L: 880~915 H: 925~960	3.5	15	50	70 at 925~960 MHz 70 at 880~915 MHz	79x54x17
DR6I897.5F942.5B15L2.5A48-60	L: 890~905 H: 935~960	2.5	15	50	48 at 935~960 MHz 60 at 890~905 MHz	57.5x20.0x8.0
MR4J902R947B25L3.0-3.5A45-500	L: 890~915 H: 935~960	3.0 3.5	14	50	45 at 935~960 MHz 50 at 890~915 MHz	30.0x13.0x5.0
MCD902F947B25L1.5A62 (Ceramic Encased Duplexer)	L: 890~915 H: 935~960	1.5	15	50	62 at 935~960 MHz 62 at 890~915 MHz	95x45x32 SMA Female
DR6J906F951B18L3.8A25	L: 897.5~915 H: 942.5~960	4.0	12	50	25 at 928.5 MHz 15 at 890, 935 MHz	65.0x15.0x8.0
M8H1400F1485B20L1.5A40	L: 1390~1410 H: 1475~1495	1.5	14	50	40 at 1475 MHz 40 at 1410 MHz	32.2x7.20x8.00
DR8I1542F1643B34L1.4A55	L: 1525~1559 H: 1626.5~1660.5	1.35	14	50	65 at 1626.5~1660.5 MHz 55 at 1525~1559 MHz	75.5x2.54x10.16
MR15J1542/1643B34L1.0A60-65	L: 1525~1559 H: 1626.5~1660.5	1.0	14	50	65 at 1625~1661 MHz 60 at 1525~1559 MHz	78.7x15.0x15.7
MR4J1722.5F1817.5 B27 L2.0 A50	L: 1709~1736 H: 1804~1831	2.0	15	50	50 at 1804~1831 MHz 50 at 1709~1736 MHz	30.00x13.00x5.0
MR10L1732.5F2132.5 B45 L1.2 A60	L: 1710~1755 H: 2110~2155	1.2	15	50	50 at 2110~2155 MHz 50 at 1710~1755 MHz	65.0x15.0x11.5
MCD1732.5F2132.5B45L3.0A25-40 (Ceramic Encased Duplexer)	L: 1710~1755 H: 2110~2155	3.0	15	50	40 at 2000~2170 MHz 40 at 1710~1785 MHz	123x71x30 SMA Female
MR8J1747F1842B75L3.0A50	L: 1710~1785 H: 1805~1880	3.0	15	50	50 at 1805~1880 MHz 50 at 1710~1785 MHz	42.9x13.20x9.0
MR15DJ1747.5R1842.5B75 L3.5 A70	L: 1710~1785 H: 1805~1880	3.5	15	50	70 at 1805~1880 MHz 70 at 1710~1785 MHz	79x54x17
MR4J1772R1867B25L2.0A50	L: 1760~1785 H: 1855~1880	2.0	14	50	50 at 1760~1785 MHz 50 at 1855~1880 MHz	30.0x13.0x5.0
MR15L1795F2045B170/250L2.2A20	L: 1710~1880 H: 1920~2170	2.2	15	50	20 at 1920~2170 MHz 20 at 1710~1880 MHz	83.0x15.0x16.3
MCD1795F2040B170-260A40 (Ceramic Encased Duplexer)	L: 1710~1880 H: 1910~2170	2.5	14	50	40 at 1910~2170 MHz 40 at 1710~1880 MHz	115x70x35 N Female
DR6J1857.5F1937.5B15L5.0A60	L: 1850~1865 H: 1930~1945	5.00	14	50	60 at 1930~1945 MHz 60 at 1850~1865 MHz	65.0x15.0x8.0
MR8J1880/1960B60L3.2A50C	L: 1850~1910 H: 1930~1990	3.2 3.2	10	50	50 at 1930~1990 MHz 50 at 1850~1910 MHz	52.0x14.0x9.0
MC15L1880.5F1960.5B41L1.5A60S (Ceramic Encased Duplexer)	L: 1860~1901 H: 1940~1981	1.5	15	50	60 at 1940 MHz 60 at 1901 MHz	85x45x32 SMA Female
MCD1882.5F1962.5B65L3.0A20 (Ceramic Encased Duplexer)	L: 1850~1915 H: 1930~1995	3.0	14	50	20 at 1930~1995 MHz 20 at 1850~1915 MHz	123x71x30 SMA Female
MR15DJ1882.5R1962.5 B65 L4.5 A70	L: 1850~1915 H: 1930~1995	4.5	15	50	70 at 1930~1995 MHz 70 at 1850~1915 MHz	79x54x17
M4J1950F2140 B60L2.0 A55	L: 1920~1980 H: 2110~2170	2.0	14	50	55 at 2110~2170 MHz 55 at 1920~1980 MHz	26.6x5.50x4.10
MR15DJ1950R2140B60 L3.0 A70	L: 1920~1980 H: 2110~2170	3.0	15	50	70 at 2110~2170 MHz 70 at 1920~1980 MHz	79x54x17

Ceramic Filter, Duplexer and Multiplexer (Mono-Block & Discrete Type)

Ceramic Duplexer

Part Number	Freq. Range (MHz)	I.L (dB) max	R.L (dB) min	Imped. (ohms)	Attenuation (dB) / min	Dimension W x L x H (mm)
MR15L1950/2140B60L1.5/1.8A60/65	L:1920~1980 H:2110~2170	1.5 1.8	15	50	65 at 2110~2170 MHz 60 at 1920~1980 MHz	90.0x30.0x17.0
MCD1950F2140B60L1.2A62 (Ceramic Encased Duplexer)	L: 1920~1980 H: 2110~2170	1.2	15	50	62 at 2110~2170 MHz 62 at 1920~1980 MHz	95x45x32 SMA Female
MR15DJ1950F2140 B60 L3.0 A70	L:1920~1980 H:2110~2170	3.0	16	50	70 at 2110~2170 MHz 70 at 1920~1980 MHz	74.0x48.0x17.0
DR6J1960F2140B60L2.5A10	L: 1930~1990 H: 2110~2170	2.5	15	50	40 at 1710~1785 MHz 40 at 2400~4100 MHz	83.0x15.0x6.5
MR4J1972/2162B17L2.0A50C	L: 1964~1981 H: 2154~2171	2.0 2.0	14	50	50 at 2154~2171 MHz 50 at 1964~1981 MHz	30.0x8.80x5.0
MD2300F2385 B20 L1.5 A40	L: 2290~2310 H: 2375~2395	1.5	14	50	40 at 2375 MHz 40 at 2310 MHz	32.0x9.20x8.20
MR8J2415/2465B30L3.0A20	L: 2400~2430 H: 2450~2480	3.0 3.0	14	50	20 at 2450~2480 MHz 20 at 2400~2430 MHz	43.5x13.0x9.0
MR10L2528.5F2655B57-70L2.5 A60	L: 2500~2557 H: 2620~2690	2.5	15	50	60 at 2620~2690 MHz 60 at 2500~2557 MHz	65.0x15.0x11.5
MR6J2535F2655B70L2.0A45	L : 2500~2570 H: 2620~2690	2.0	14	50	45 at 2620~2690 MHz 45 at 2500~2570 MHz	30.0x9.60x6.50
MR8DL2535R2655B70L4.5A70	L: 2500~2570 H: 2620~2690	4.5	15	50	70 at 2620~2690 MHz 70 at 2500~2570 MHz	79x54x17
M10J3412F3512B25L2.2A50	L: 3400~3425 H: 3500~3525	2.2	15	50	50 at 3500~3525 MHz 50 at 3400~3425 MHz	52.5x6.40x10.3
MR10L3450F3550B20L2.5A50	L:3440~3460 H:3540~3560	2.5	14	50	50 at 3540~3560 MHz 50 at 3440~3460 MHz	67.0x11.0x11.3
M10J3614F3714B28L2.2A50	L: 3600~3628 H: 3700~3728	2.2	15	50	50 at 3700~3728 MHz 50 at 3600~3628 MHz	52.5x6.40x10.3
M10J3638F3738B28L2.2A50	L: 3624~3652 H: 3724~3752	2.2	15	50	50 at 3724~3752 MHz 50 at 3624~3652 MHz	52.5x6.40x10.3

► Performance

◆ MR15DJ1747.5R1842.5B75 L3.5 A70

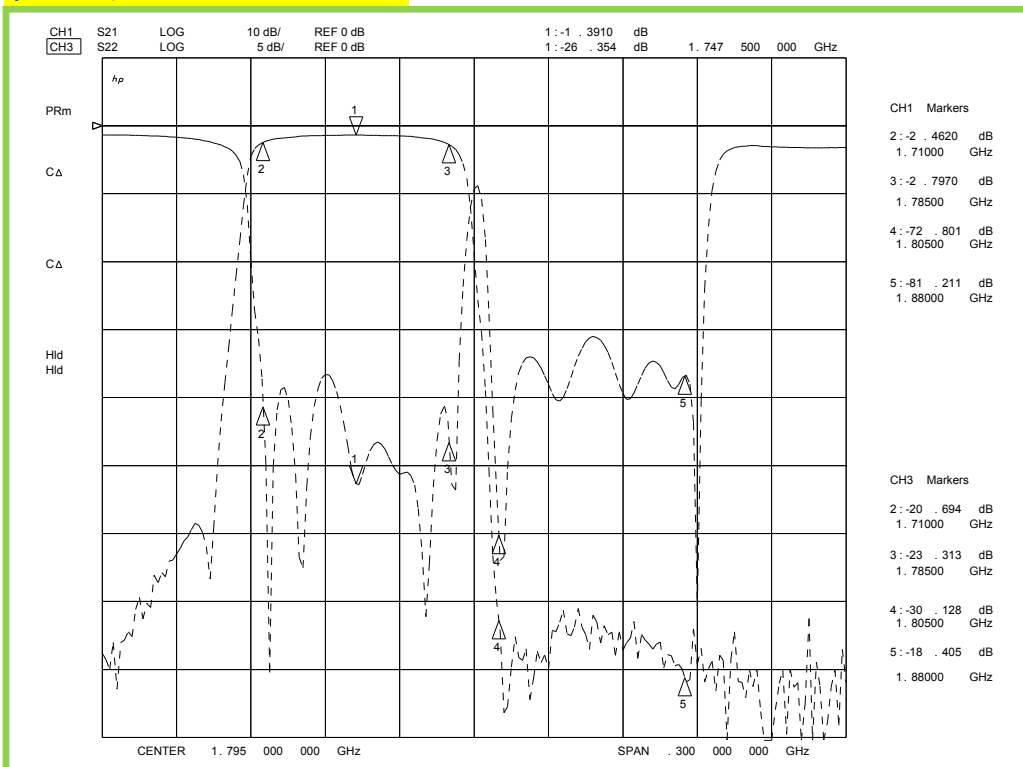

Ceramic Filter, Duplexer and Multiplexer (Mono-Block & Discrete Type)

Ceramic Duplexer

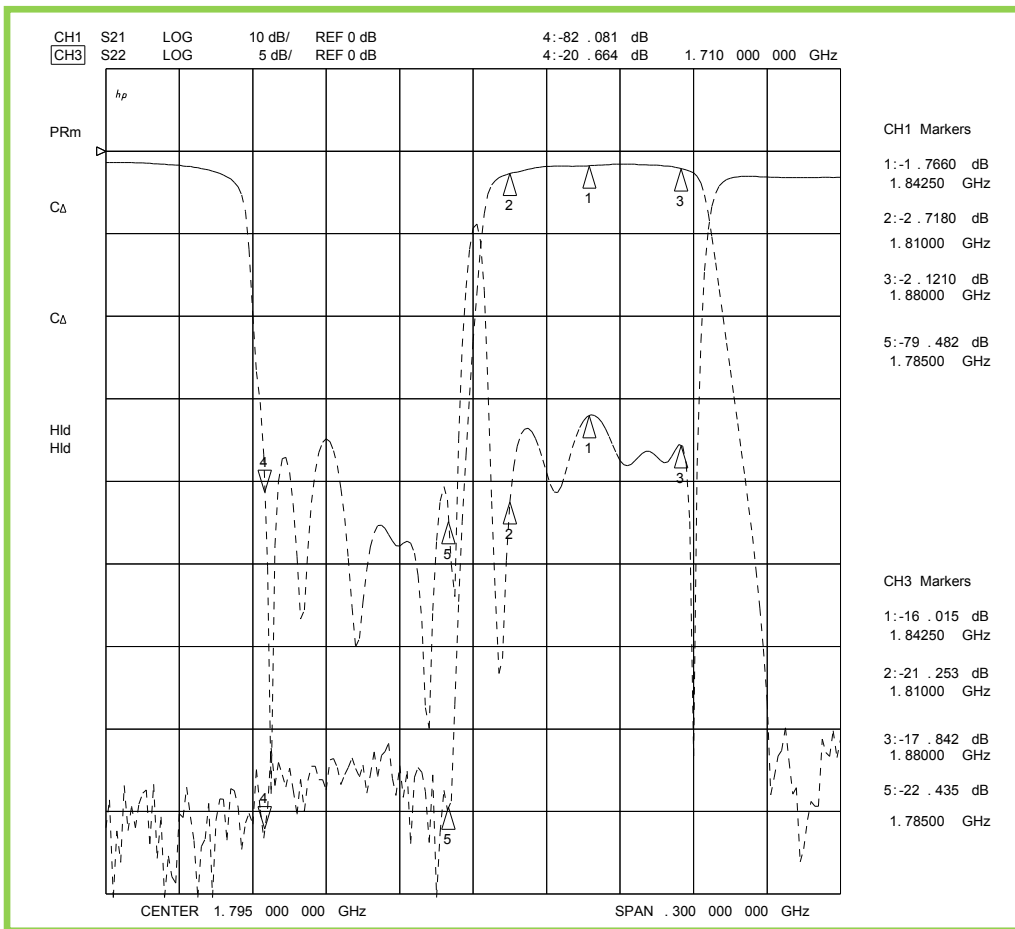

► Dimension(mm) (MR15DJ1747.5R1842.5B75 L3.5 A70)

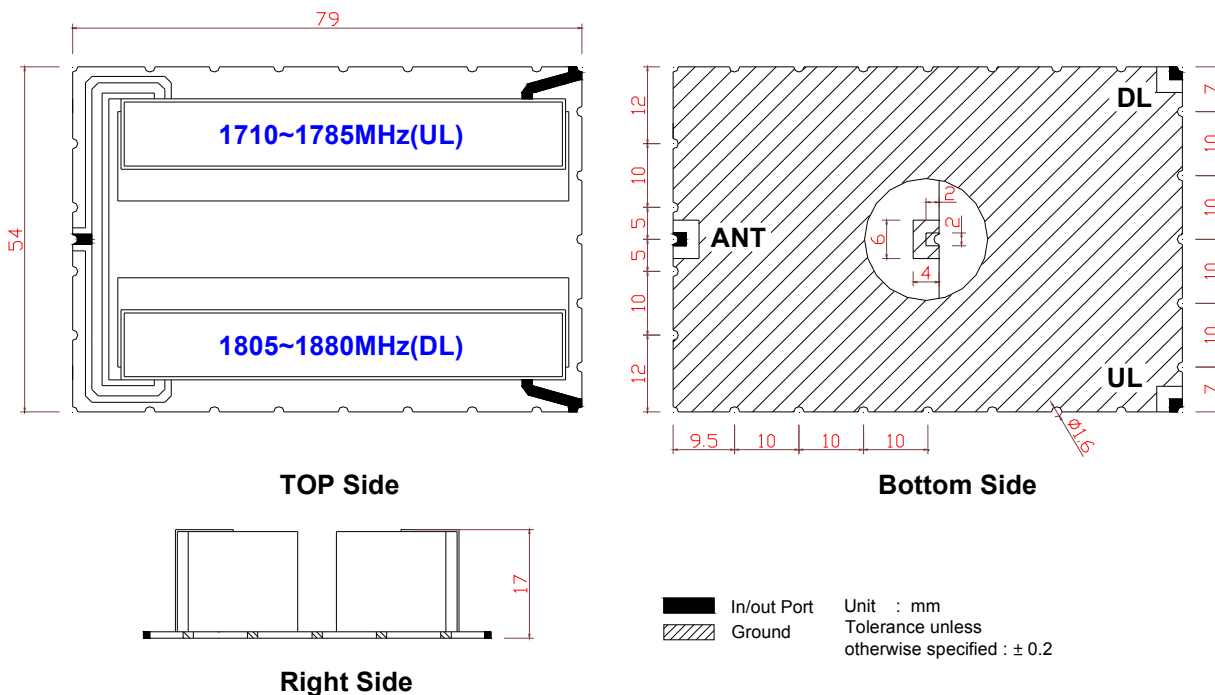

Ceramic Filter, Duplexer and Multiplexer (Mono-Block & Discrete Type)

Ceramic Notch Filter

Part Number	Freq. Range (MHz)	I.L (dB) max	R.L (dB) min	Imped. (ohms)	Attenuation (dB) / min	Dimension W x L x H (mm)
DRN4D470-862B8L1.8A40 (Ceramic Notch Filter)	470~862	1.8	17	50	40 at 887~895 MHz	18.0x14.0x5.30
MRN8J 841-879 B18 L3.5 A35 (Ceramic Notch Filter)	831~841 879~889	3.5	15	50	35 at 851~869 MHz	42.0x16.0x9.50
MRN8J 859-904 B25 L3.5 A35 (Ceramic Notch Filter)	849~859 904~914	3.5	15	50	35 at 869~894 MHz	42.0x16.0x9.50
MRN8J910-980B39L3.5A30 (Ceramic Notch Filter)	900~910 980~990	3.5	15	50	30 at 921~960 MHz	42.0x16.0x9.50
DCN8E387.5 B15 L1.0 A60 (Ceramic Notch Filter)	200~360 420~520	1.0	14	50	60at 380~395 MHz	90x70x30 N Female
DRNF1747-1950L2.5A20 (Ceramic Notch Filter)	1710~1785 1920~1980	2.5	12	50	20 at 1805~1880 MHz	38.0x16.0x8.0
MRN6J1785-1900B75L3.5A35 (Ceramic Notch Filter)	1775~1785 1900~1910	3.5	15	50	35 at 1805~1880 MHz	32.0x16.0x7.50
MRN6J1910-2010 B60 L3.5 A35 (Ceramic Notch Filter)	1900 ~ 1910 2010~2020	3.5	15	50	35 at 1930~1990 MHz	32.0x16.0x7.50
MRN6J2090-2190B60L3.5A35 (Ceramic Notch Filter)	2080~2090 2190~2200	3.5	15	50	35 at 2110~2170 MHz	32.0x16.0x7.50

► Performance

◆MRN6J1910-2010 B60 L3.5 A35

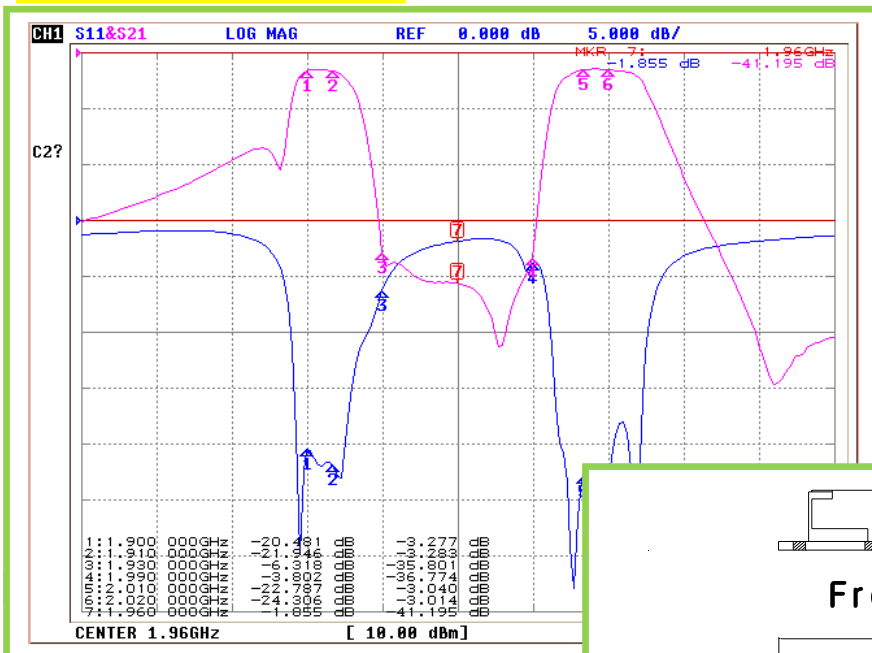

► Dimension

(MRN6J1910-2010 B60 L3.5 A35)

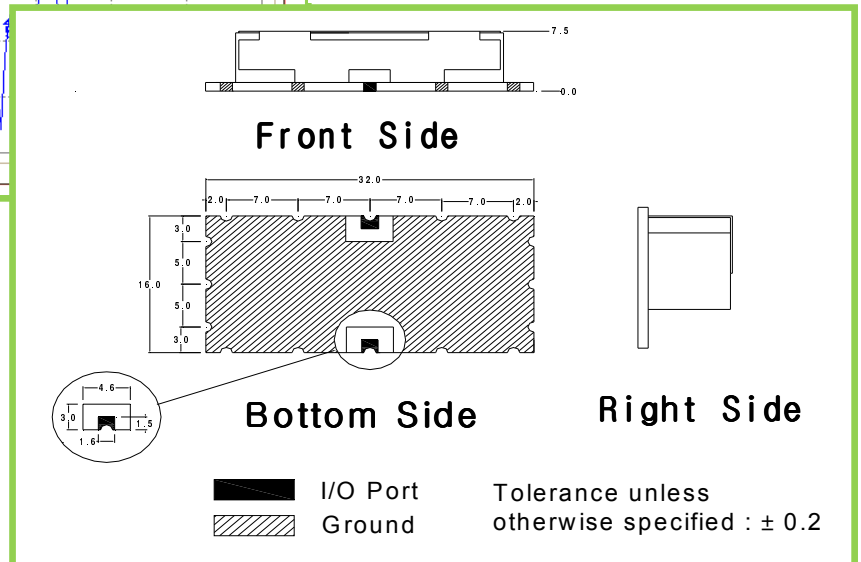

■ Ceramic Filter, Duplexer and Multiplexer(Mono-Block & Discrete Type)

Ceramic Notch Filter

◆DCN8E387.5 B15 L1.0 A60

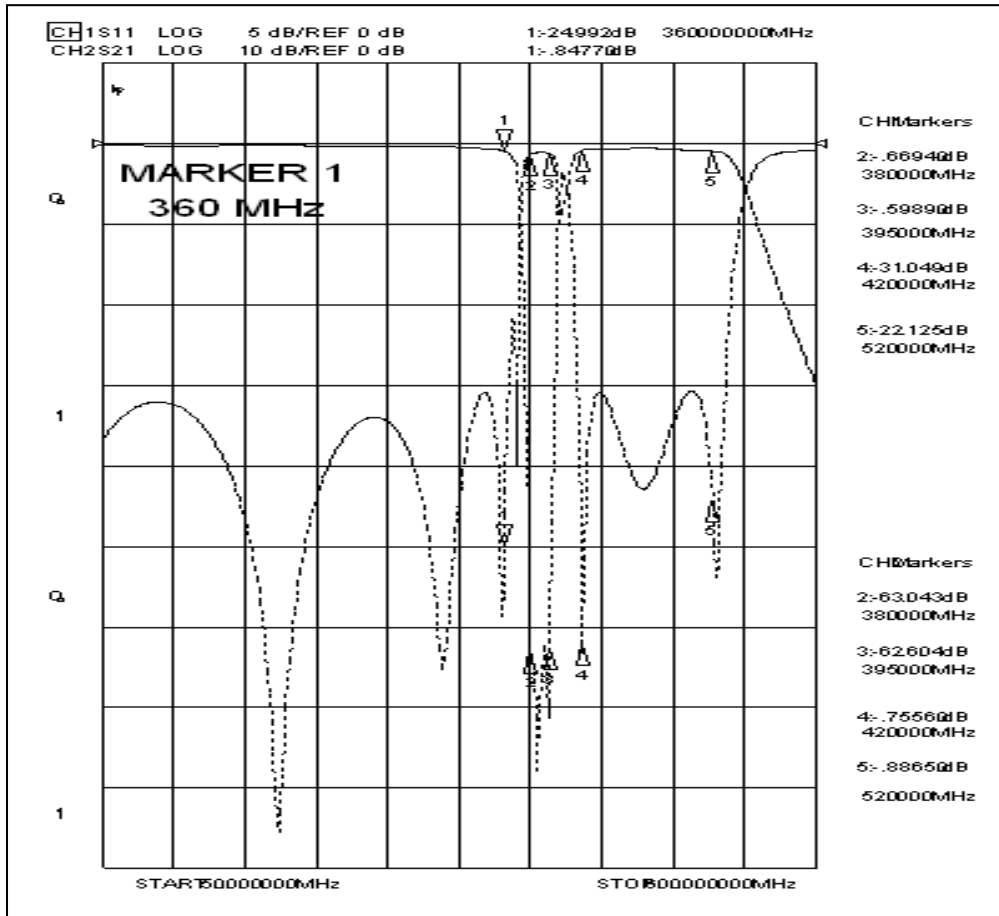

► Dimension(DCN8E387.5 B15 L1.0 A60)

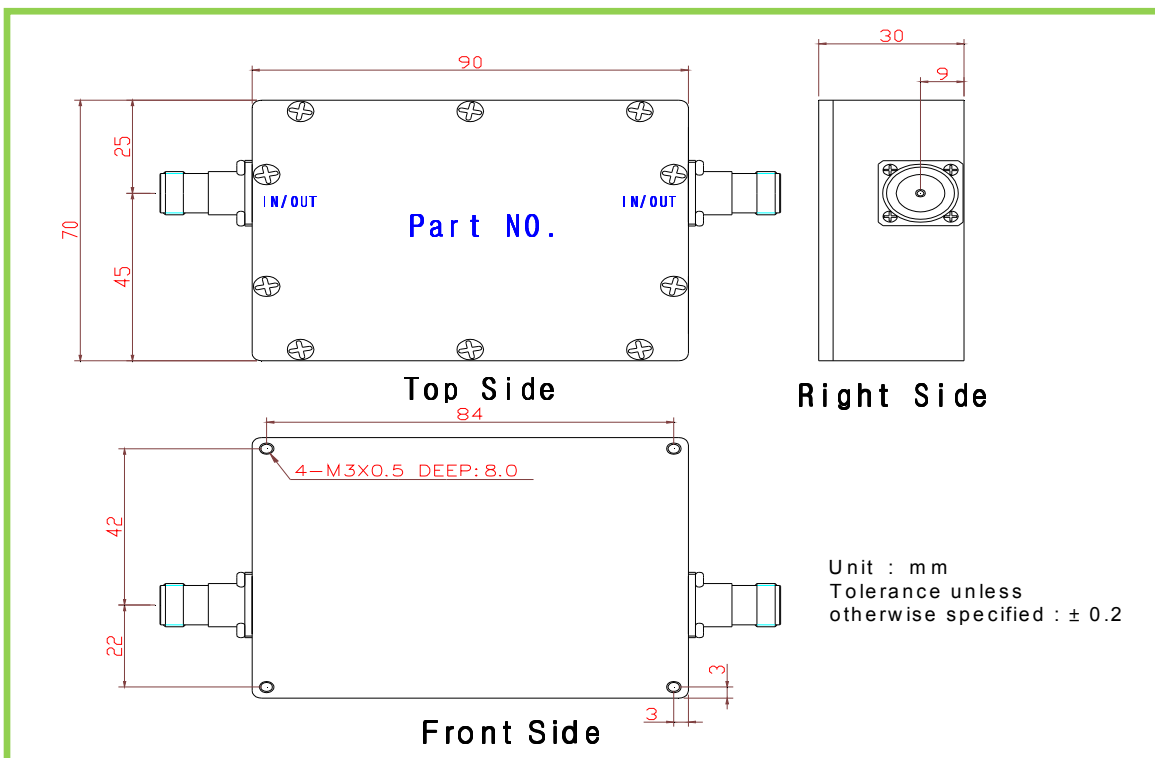

■ Ceramic Filter, Duplexer and Multiplexer(Mono-Block & Discrete Type)

Ceramic Multiplexer

Part Number	Freq. Range (MHz)	I.L (dB) max	R.L (dB) min	Imped. (ohms)	Attenuation (dB) / min	Dimension W x L x H (mm)
MR8L742.5-707-781.5 L3.5 A60 (Ceramic Triplexer)	L: 698 ~ 716 H: 776 ~ 787 M: 728 ~ 757	3.0 3.0 3.5	15	50	L: 10 at 100~650 MHz 50 at 728~757 MHz 35 at 824~849 MHz	66.0x42.5x9.5
					M: 50 at 869~894 MHz	
					H: 10 at 100~650 MHz 60 at 698~716 MHz 60 at 776~787 MHz 40 at 824~960 MHz	
MRM532.5F1442.5F1810L2.5A35B (Ceramic Triplexer)	L: 385~680 M: 1395~1490 H: 1710~1910	2.5	14	50	L: 45 at 1350 MHz 48 at 1395 MHz	34.0x25.0
					M: 60 at 680 MHz 40 at 1710 MHz	
					H: 40 at 1490 MHz 17 at 2000 MHz	
MRM532.5R1442.5R1810L2.5A35A (Ceramic Triplexer)	L: 385~680 M: 1395~1490 H: 1710~1910	2.5	14	50	L: 45 at 1350 MHz 48 at 1395 MHz	34.0x25.0
					M: 60 at 680 MHz 40 at 1710 MHz	
					H: 40 at 1490 MHz 17 at 2000 MHz	
MRM622.5F2065F2342.5L2.5A30B (Ceramic Triplexer)	L: 485~760 M: 1975~2155 H: 2295~2390	2.5	14	50	L: 25 at 980 MHz 45 at 1400 MHz 55 at 1975 MHz	34.0x25.0
					M: 30 at 2295 MHz 60 at 760 MHz	
					H: 35 at 2155 MHz 12 at 2465 MHz	
MRM622.5R2065R2342.5L2.5A30A (Ceramic Triplexer)	L: 485~760 M: 1975~2155 H: 2295~2390	2.5	14	50	L: 25 at 980 MHz 45 at 1400 MHz 55 at 1975 MHz	34.0x25.0
					M: 30 at 2295 MHz 60 at 760 MHz	
					H: 35 at 2155 MHz 12 at 2465 MHz	
MR8J772-872.5-938 L2.0 A17L (Ceramic Mono-block + LC type)	L: 769 ~ 775 M: 851 ~ 894 H: 935 ~ 941	2.0	15	50	L: 35 at 851~894 MHz 35 at 935~941 MHz	52.0x28.5x9.5
					M: 35 at 935~941 MHz 17 at 769~775 MHz	
					H: 35 at 851~ 894 MHz 17 at 769~ 775 MHz	

■ Ceramic Filter, Duplexer and Multiplexer(Mono-Block & Discrete Type)

Ceramic Multiplexer

Part Number	Freq. Range (MHz)	I.L (dB) max	R.L (dB) min	Imped. (ohms)	Attenuation (dB) / min		Dimension W x L x H (mm)
					L :	M : H :	
DRLT942.5R1842.5R2140L1.0-F1.5A30R20 (DR + LC LPF Type Triplexer)	PI : 925~960 P2 : 1805~1880 P3: 2110~2170	P1: 1.0 P2,3: 1.5	18	50	L : 30 at P2~P3 at 1500~1600	M : 20 at P1,P3 H : 20 at 925~1880 20 at 1200~1600	34.0x25.0x6.0
MR6JT742R872R935L3.0A23 (Ceramic Triplexer)	PI : 728 ~ 757 P2 : 851 ~ 894 P3: 929 ~ 941	3.0	15	50	Port Isolation 23 min		55x22x10
MR6J2140F2392F2760L1.7A25 (Ceramic Triplexer)	PI : 728 ~ 757 P2 : 851 ~ 894 P3: 929 ~ 941	2.0	15	50	Port Isolation 25 min		40x17x7.5
MR8J 707-742-781B18-29-11 L3.0A35 (Ceramic Triplexer)	PI : 728 ~ 757 P2 : 776 ~ 787 P3: 698 ~ 716	3.0	15	50	Port Isolation 35 min		56.5x32.5x9.5
MR8J 707-742-781B18-29-11 L3.5A40 (Ceramic Triplexer)	PI : 728 ~ 757 P2 : 776 ~ 787 P3: 698 ~ 716	3.5	15	50	Port Isolation 40 min		56.5x32.5x9.5
MR8L 707-742-781B18-29-11 L3.5A60 (Ceramic Triplexer)	PI : 728 ~ 757 P2 : 776 ~ 787 P3: 698 ~ 716	3.5	15	50	Port Isolation 60 min		66x42.5x9.5
MC15LS700-800-1700-2100L16A20NS (Ceramic Multiplexer)	CDMA800 PCS1900 AWR1700 LTE 700 (4G)	16	15	50	Port Isolation 60 min		19" Rack Mount
MC15LS700-800-1800-2100L16A20NS (Ceramic Multiplexer)	CDMA800 DCS1800 UMTS2100 LTE 700 (4G)	16	15	50	Port Isolation 60 min		19" Rack Mount
MC15LS900-1800-2100-2500L16A20NS (Ceramic Multiplexer)	GSM900 DCS1800 UMTS2100 LTE 2500 (4G)	16	15	50	Port Isolation 60 min		19" Rack Mount
MC8JS700-800-1900L4.0A25 (Ceramic Multiplexer)	PI : 707 & 781.5 P2 : 728~757 P3: 824~849 P4: 869~894 P5: 1850~1915 P6: 1930~1995	3.5	15	50	Port Isolation 25 min		144x90x15
MC8JS700-808-900 L3.5A25 (Ceramic Multiplexer)	PI : 793~824 P2 : 763~775 P3: 793~824 P4: 851~869 P5: 896~902 P6: 935~941	6.5 3.5	15	50	Port Isolation 25 min		144x90x15

■ Ceramic Filter, Duplexer and Multiplexer(Mono-Block & Discrete Type)

Ceramic Multiplexer

► Performance

◆ MR8J 707-742-781B18-29-11 L3.0A35

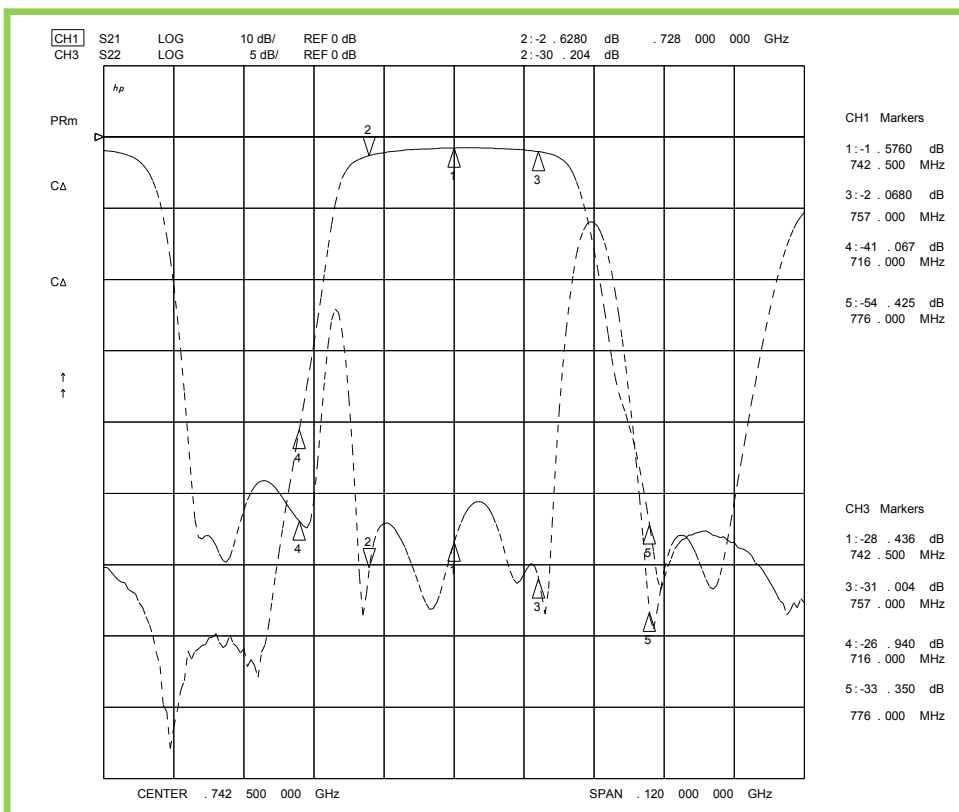
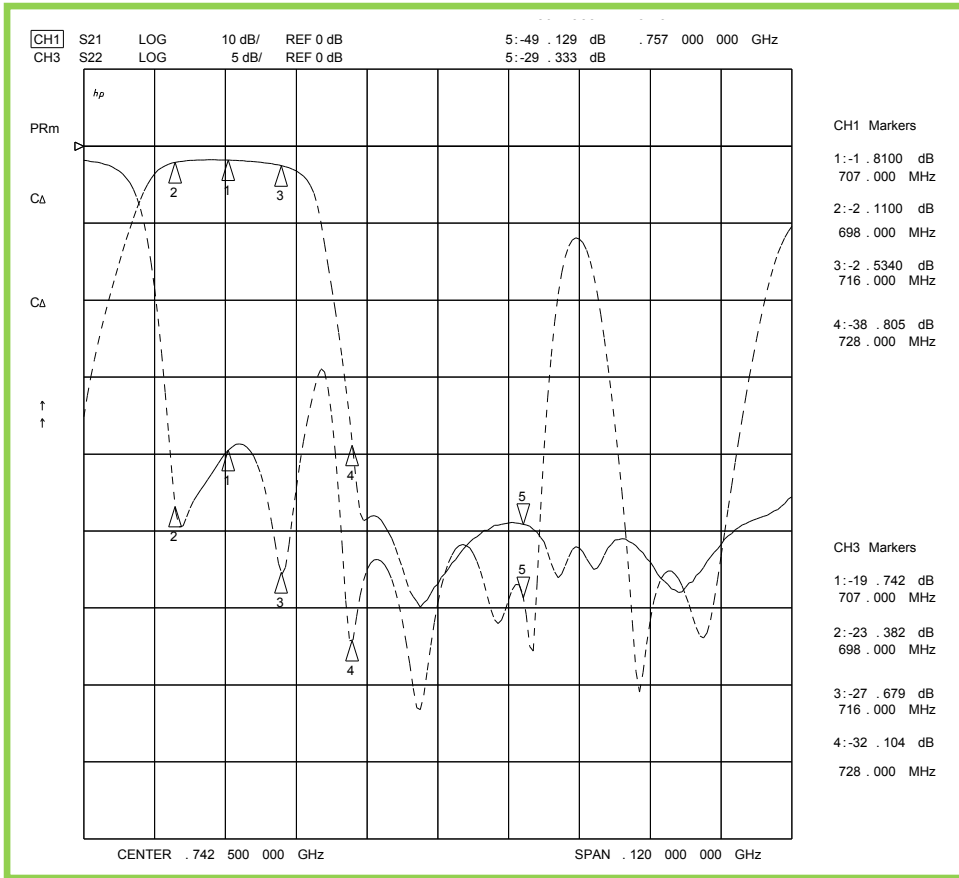

■ Ceramic Filter, Duplexer and Multiplexer(Mono-Block & Discrete Type)

Ceramic Multiplexer

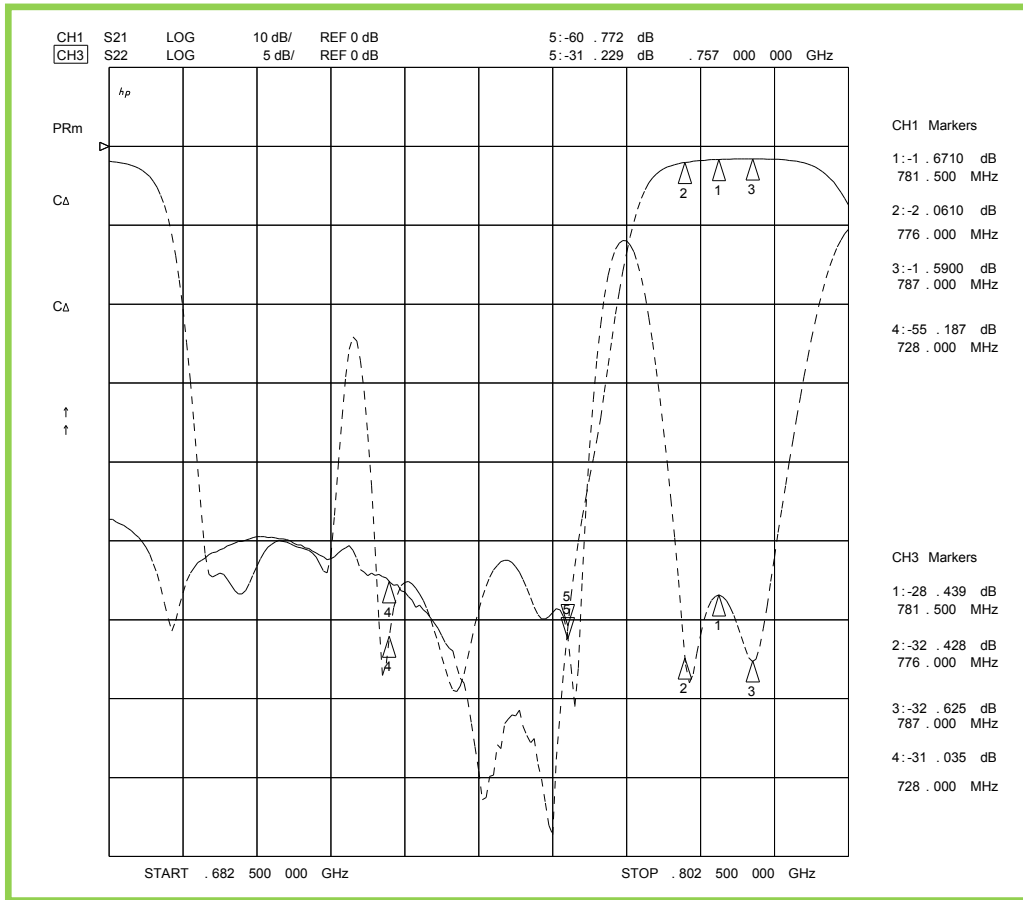

► Dimension(MR8J 707-742-781B18-29-11 L3.0A35)

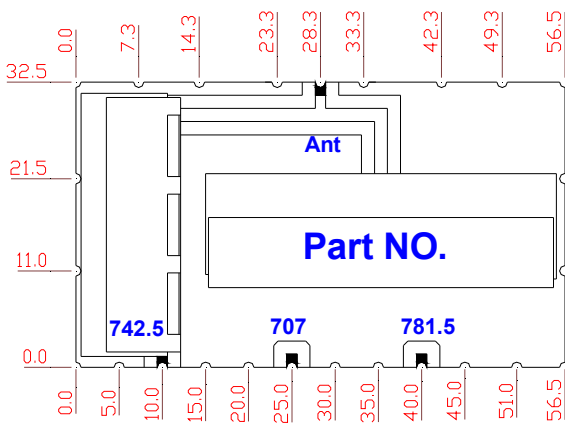

TOP Side

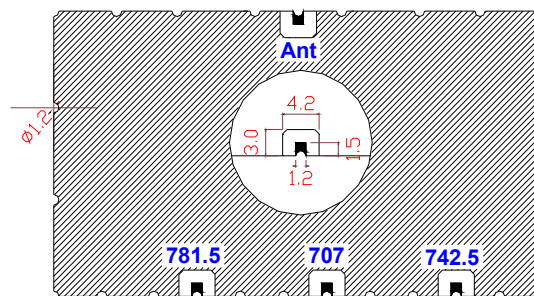

Bottom Side

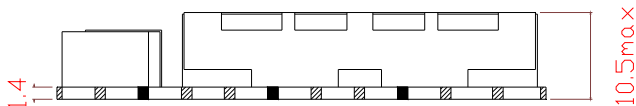

Front Side

Unit : mm
 Tolerance unless
 otherwise specified : ± 0.2

■ LOW/ANT/HIGH Port
 ▨ Ground

■ Ceramic Filter, Duplexer and Multiplexer(Mono-Block & Discrete Type)

Ceramic Multiplexer

► Performance

◆ MC15LS700-800-1700-2100L16A20NS

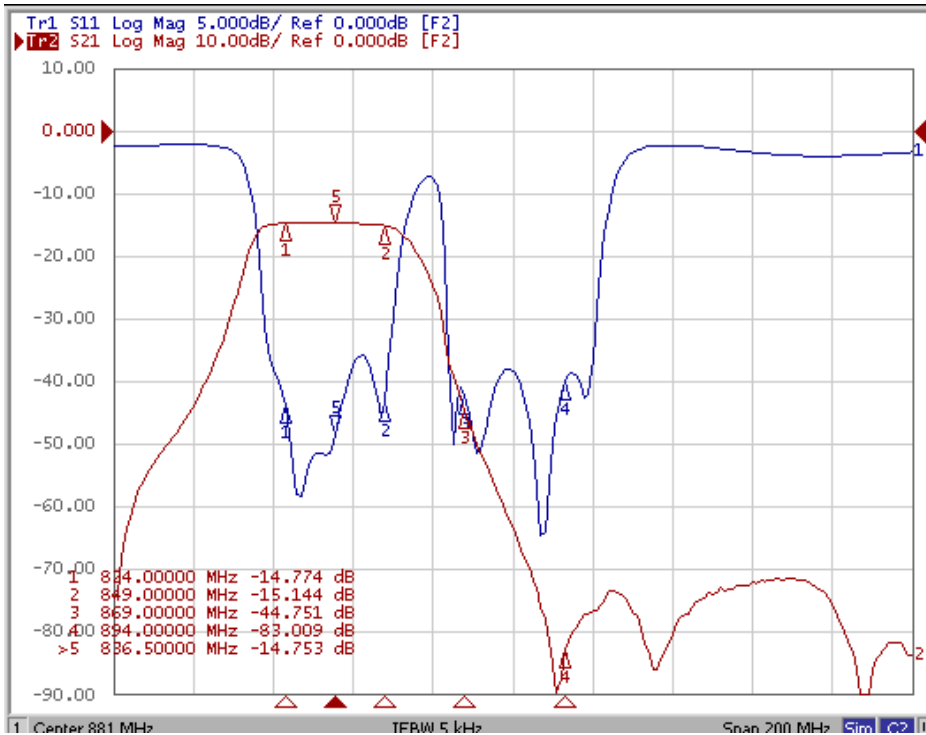

■ Ceramic Filter, Duplexer and Multiplexer(Mono-Block & Discrete Type)

Ceramic Multiplexer

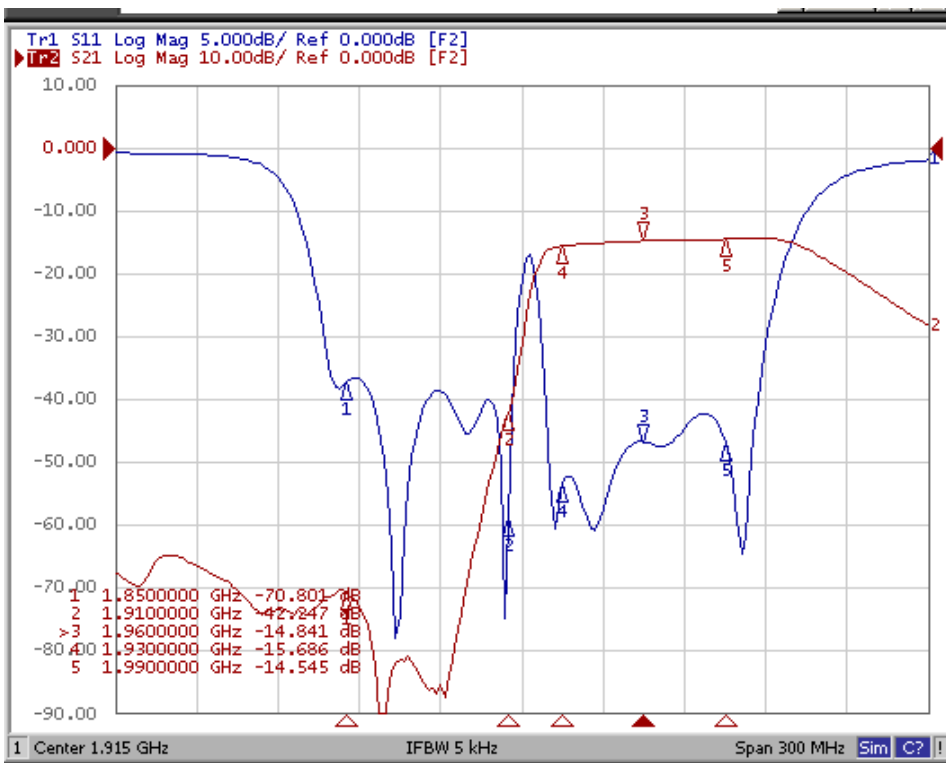
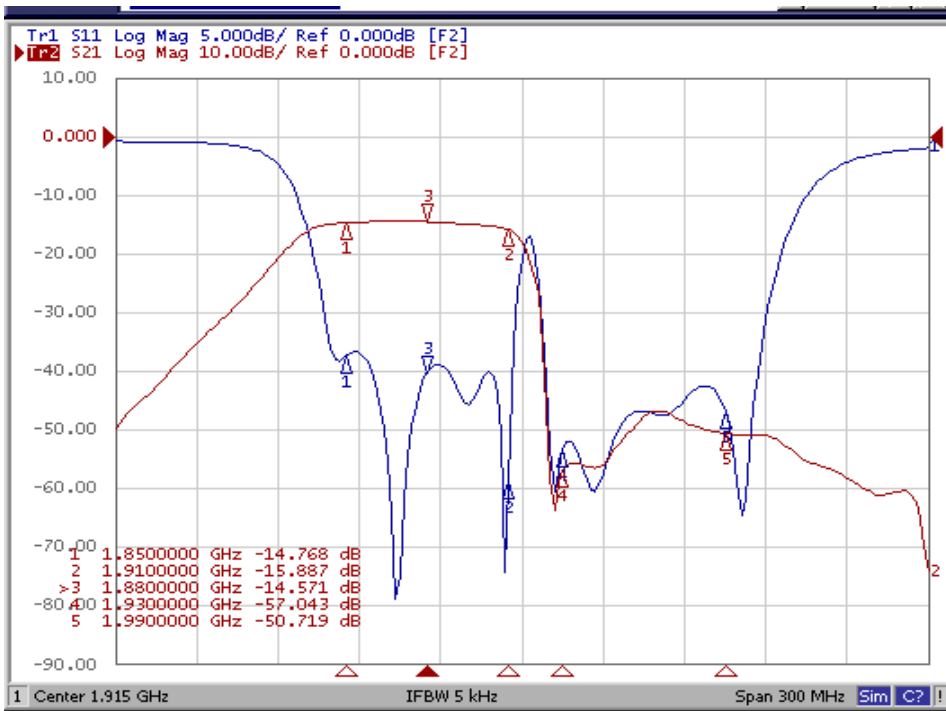

■ Ceramic Filter, Duplexer and Multiplexer(Mono-Block & Discrete Type)

Ceramic Multiplexer

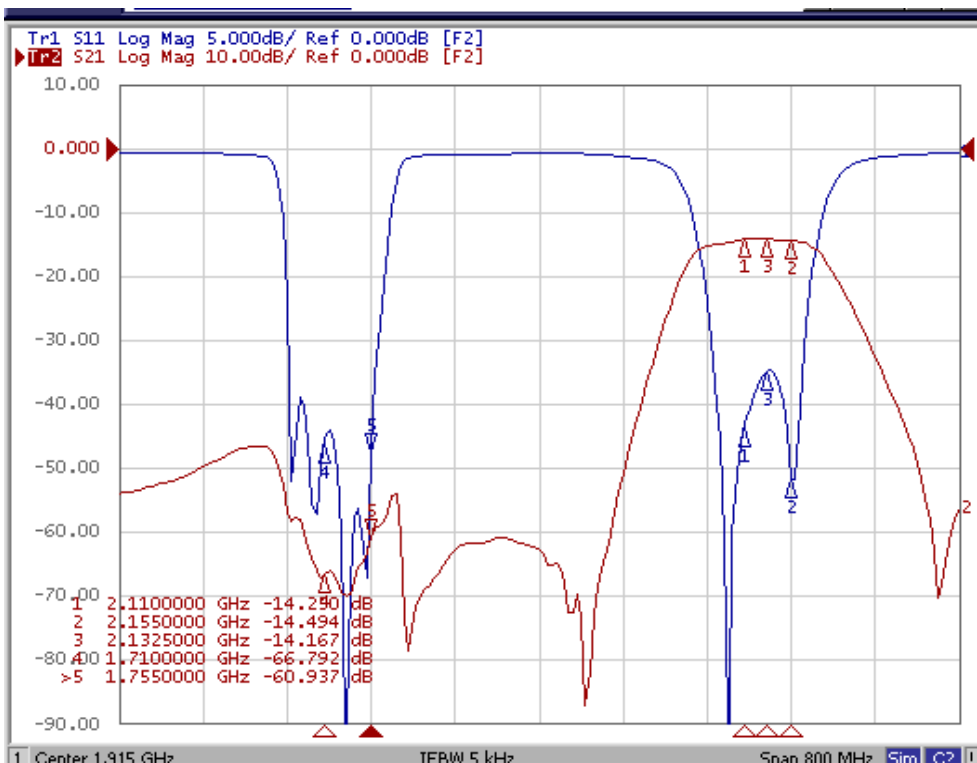
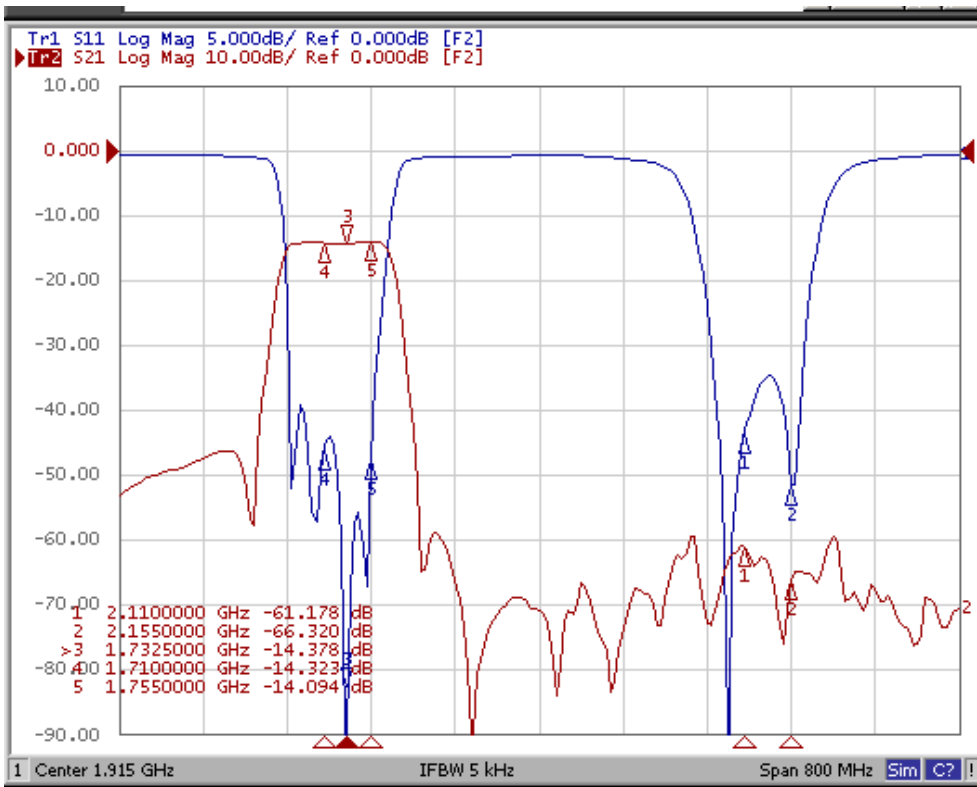

■ Ceramic Filter, Duplexer and Multiplexer(Mono-Block & Discrete Type)

Ceramic Multiplexer

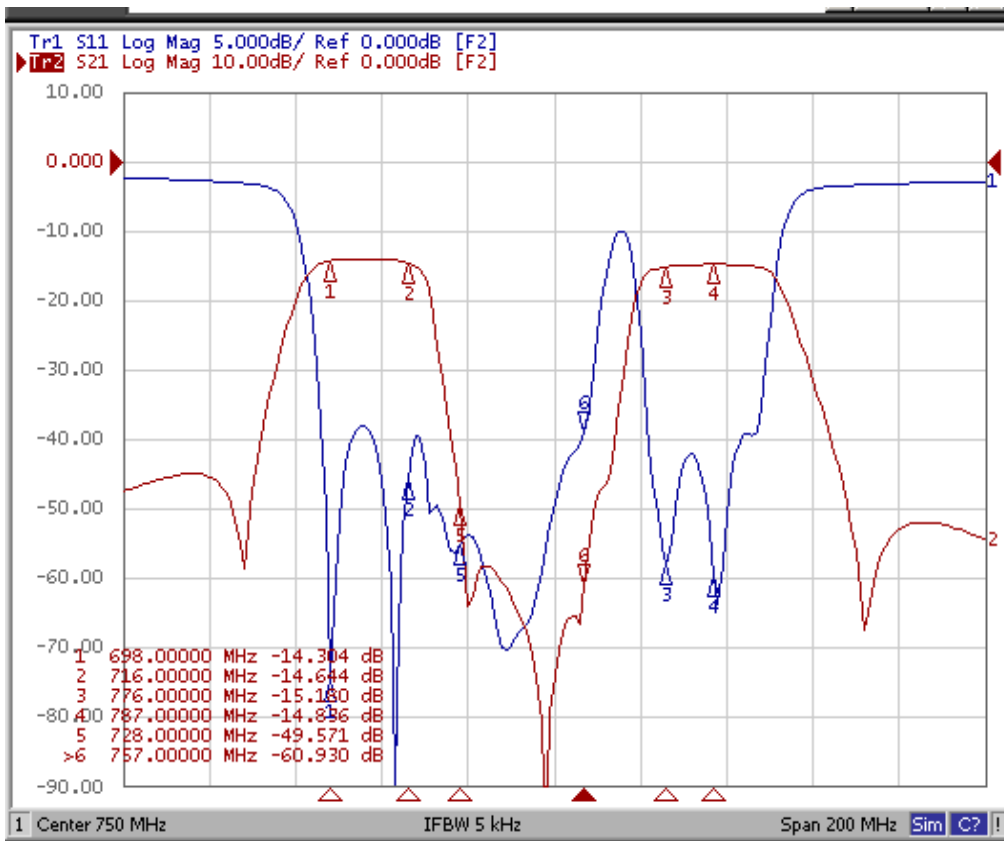
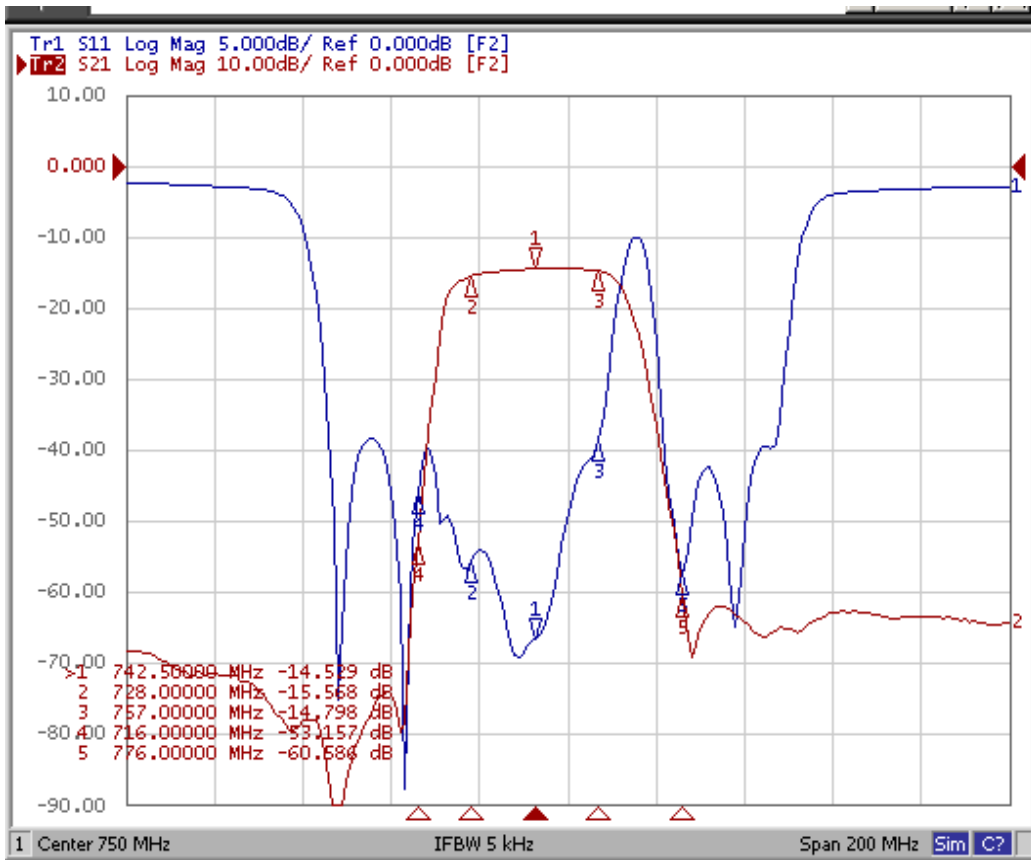

■ Ceramic Filter, Duplexer and Multiplexer(Mono-Block & Discrete Type)

Ceramic Multiplexer

► Dimension(MC15LS700-800-1700-2100L16A20NS)

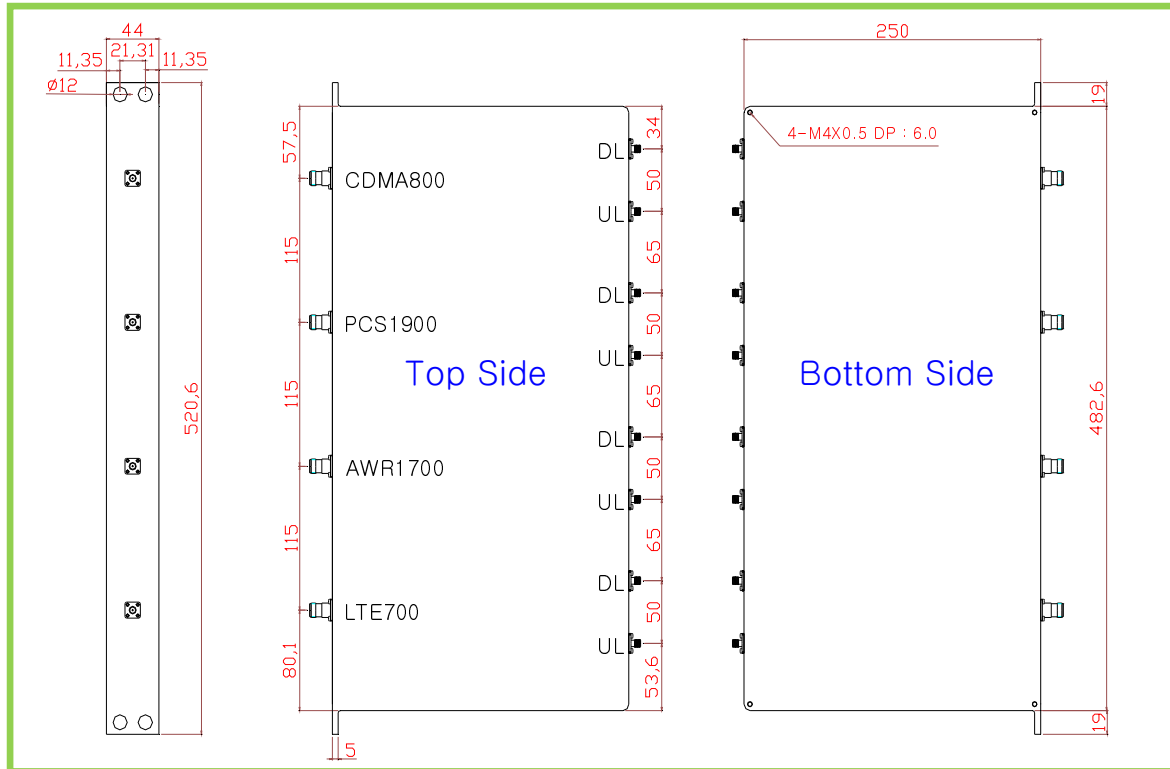

◆ MC8JS700-800-1900L4.0A25

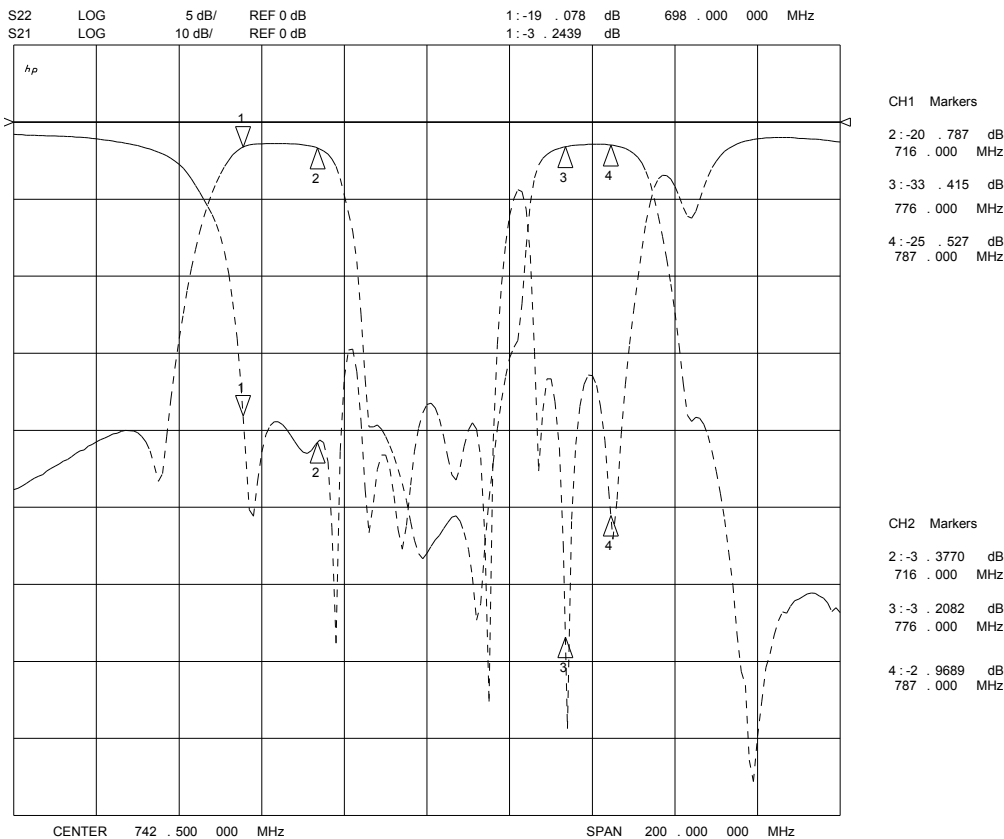

■ Ceramic Filter, Duplexer and Multiplexer(Mono-Block & Discrete Type)

Ceramic Multiplexer

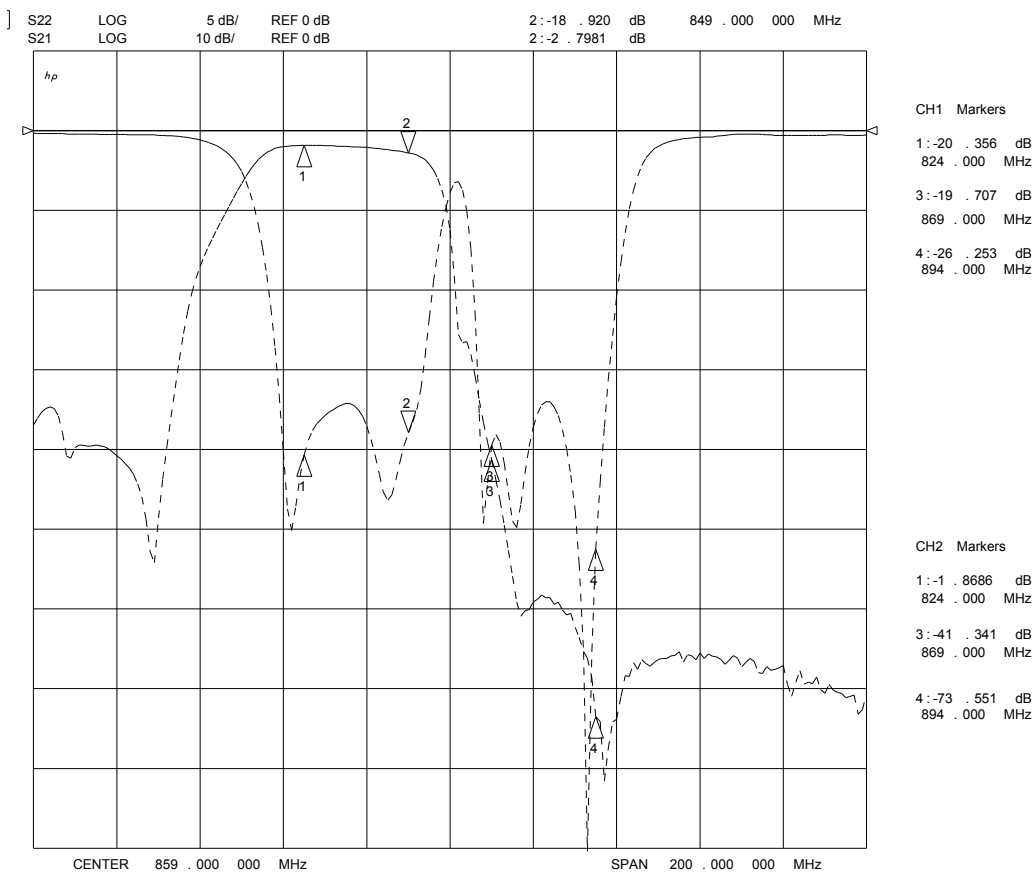
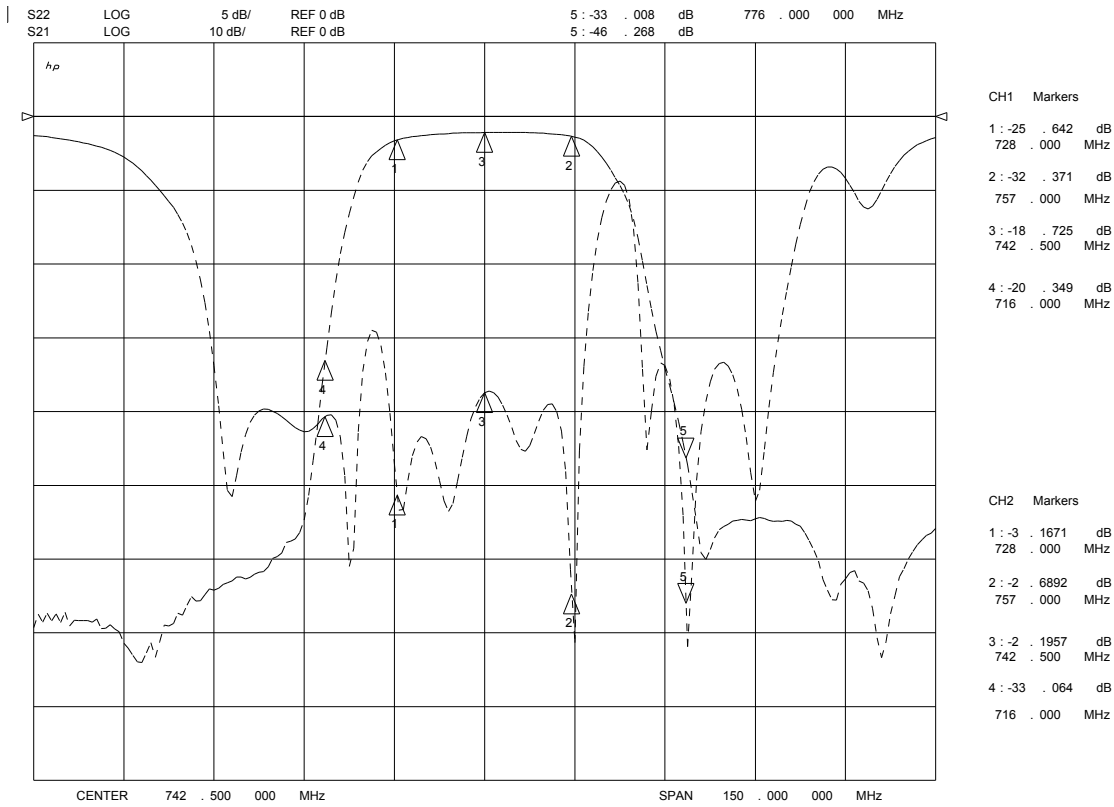

■ Ceramic Filter, Duplexer and Multiplexer(Mono-Block & Discrete Type)

Ceramic Multiplexer

S22 LOG 5 dB/ REF 0 dB 1: -19 .845 dB 824 .000 000 MHz
 S21 LOG 10 dB/ REF 0 dB 1: -60 .687 dB

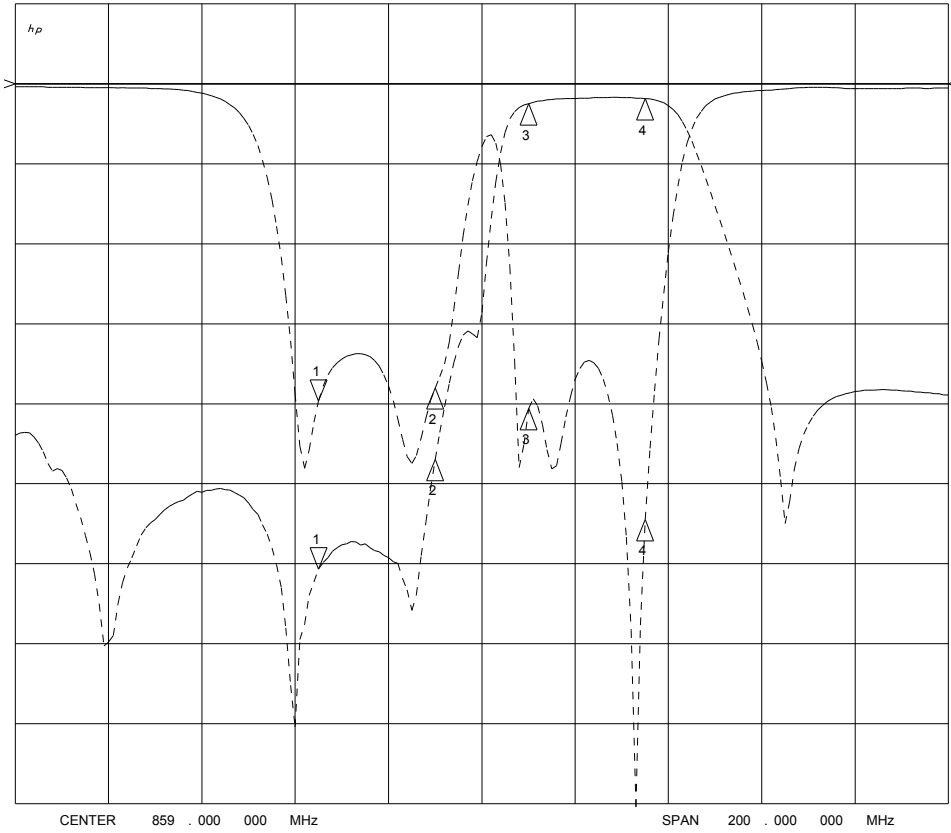

CH1 Markers
 2: -18 .997 dB
 849 .000 MHz
 3: -20 .308 dB
 869 .000 MHz
 4: -27 .244 dB
 894 .000 MHz

CH2 Markers
 2: -46 .973 dB
 849 .000 MHz
 3: -2 .4609 dB
 869 .000 MHz
 4: -1 .8716 dB
 894 .000 MHz

1 S22 LOG 5 dB/ REF 0 dB 2: -25 .213 dB
 2 S21 LOG 10 dB/ REF 0 dB 2: -3 .4873 dB 1 915 .000 000 MHz

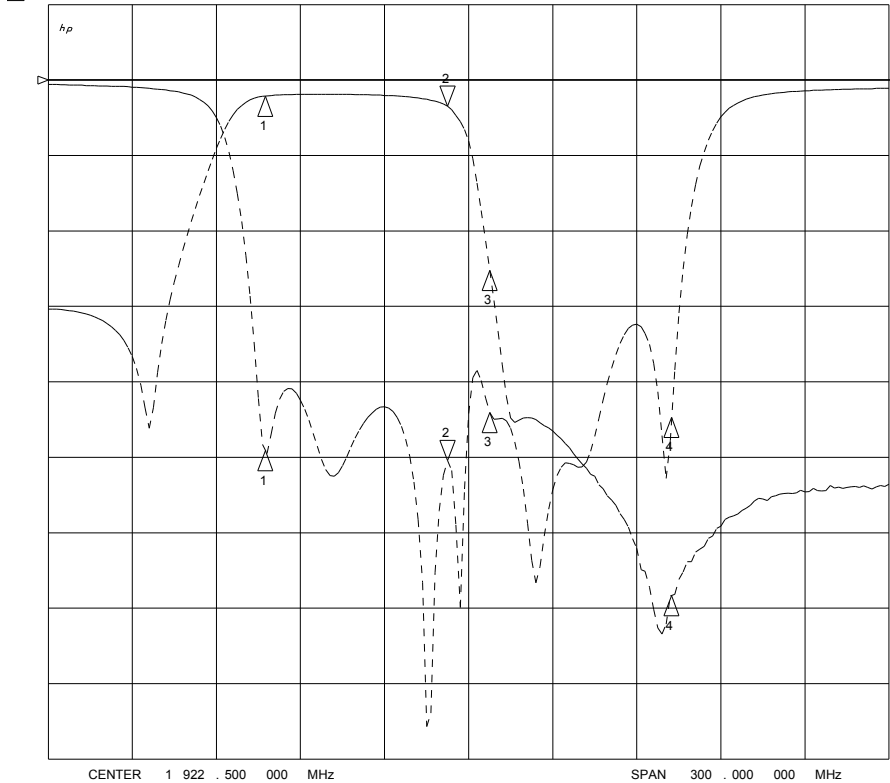

CH1 Markers
 1: -24 .558 dB
 1.85000 GHz
 3: -22 .045 dB
 1.93000 GHz
 4: -22 .345 dB
 1.99500 GHz

CH2 Markers
 1: -2 .1443 dB
 1.85000 GHz
 3: -25 .208 dB
 1.93000 GHz
 4: -68 .320 dB
 1.99500 GHz

■ Ceramic Filter, Duplexer and Multiplexer(Mono-Block & Discrete Type)

Ceramic Multiplexer

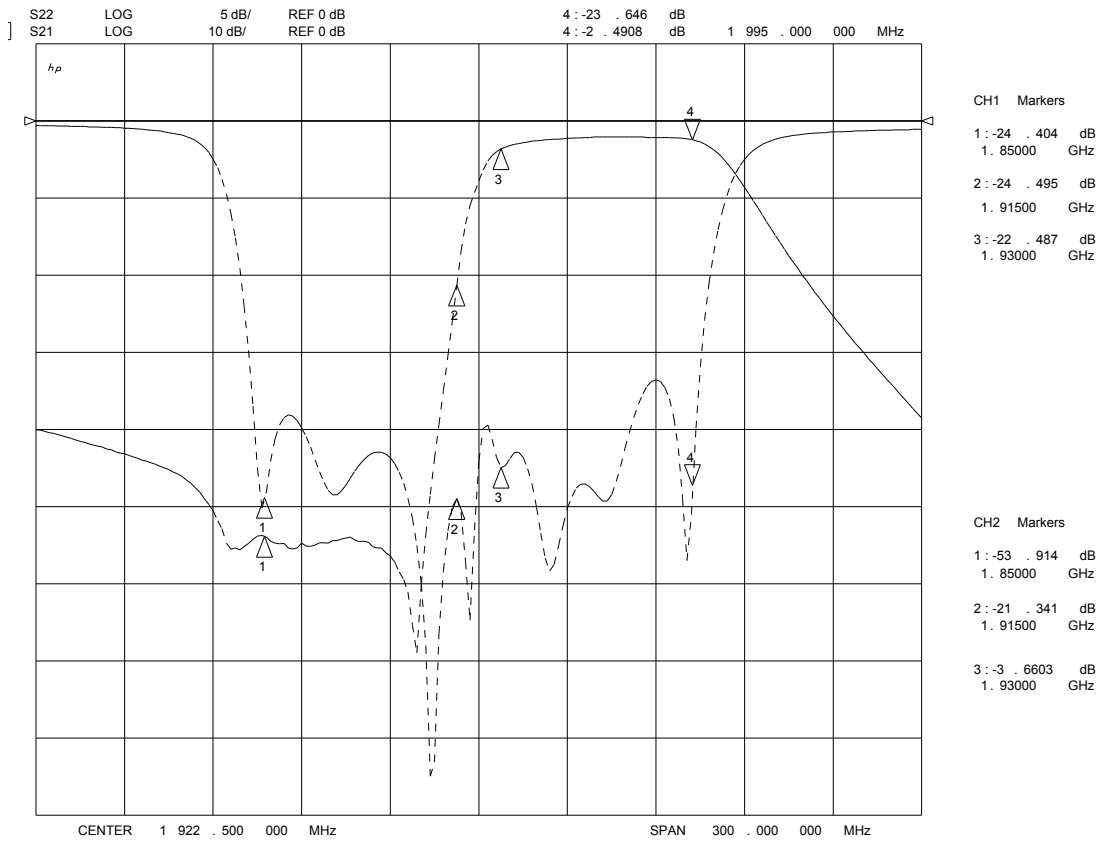
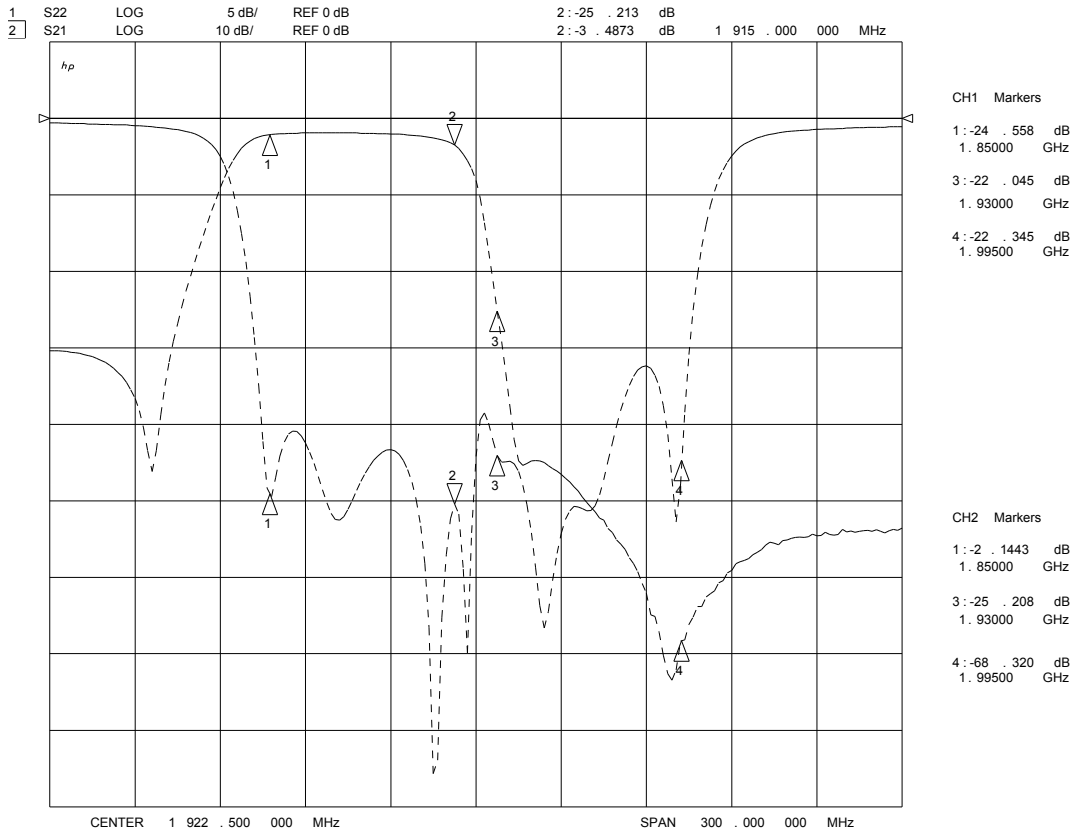

■ Ceramic Filter, Duplexer and Multiplexer(Mono-Block & Discrete Type)

Ceramic Multiplexer

► Dimension(MC8JS700-800-1900L4.0A25)

